

AL-KO



AL-KO ACCESSORIES

PREMIUM ACCESSORIES FOR YOUR CARAVAN BY THE
WORLDWIDE LEADER IN CARAVAN TECHNOLOGY

CALL US NOW ON 01926 818500,
EMAIL US MAIL@AL-KO.CO.UK
OR VISIT WWW.AL-KO.CO.UK
TO PLACE YOUR ORDER NOW.

QUALITY FOR LIFE

WELCOME

THE AL-KO RANGE OF PREMIUM CARAVAN ACCESSORIES PROVIDE ENHANCED SAFETY AND SECURITY TO COMPLEMENT THE UK'S MARKET LEADING CARAVAN CHASSIS.

As the worldwide leader in caravan chassis design and development, AL-KO's accessories are designed to make your caravan experience more relaxed and enjoyable.

The range of products contained in this brochure represent a small but very popular selection of products for caravans and trailers.

For more comprehensive information about the range of AL-KO products, accessories and spare parts, please visit our website at www.al-ko.co.uk. Products can be ordered online or via our sales hotline (01926 818500). Alternatively, visit your local AL-KO approved service centre or caravan dealer.

ALL OUR PRODUCTS CAN BE PURCHASED SECURELY ONLINE, OR QUICKLY AND EASILY THROUGH OUR CALL CENTRE. CALL US NOW ON 01926 818500 EMAIL US MAIL@AL-KO.CO.UK, OR VISIT WWW.AL-KO.CO.UK TO PLACE YOUR ORDER.

PAGE CONTENTS

1.	Welcome
2.	World of AL-KO and The Euro Axle System
3.	ATC Anti-Snake System
5.	AL-KO Secure
7.	AKS 3004
8.	AKS 1300
9.	Octagon Shock Absorbers
10.	Spare wheel Carrier
11.	Jockey Wheels
13.	Side Lift Jack
14.	Security Devices
15.	Corner Steadies
16.	Big Foot and Adapter
17.	Complementary Products



WORLD OF AL-KO

AL-KO'S EXPERIENCE AND KNOWLEDGE COMES FROM OVER 75 YEARS OF HISTORY, PRODUCING HIGH QUALITY CHASSIS AND COMPONENTS FOR THE CARAVAN AND TRAILER INDUSTRY WORLDWIDE.

AL-KO is also at the forefront of motorhome and commercial vehicle chassis conversions. Over 140,000 approved conversions have been commissioned throughout our manufacturing facilities in England, Germany, France and Italy.

Our understanding of the industry and our extensive knowledge of vehicle technology is applied to every product we manufacture. This ensures our customers receive the highest quality chassis and innovative accessories for their vehicle. Our expertise also ensures that each product is uniquely suited for its purpose, to make the vehicle safer, more stable and more reliable.

AL-KO are also leaders in the design and production of garden and hobby machinery and air purifying technology.

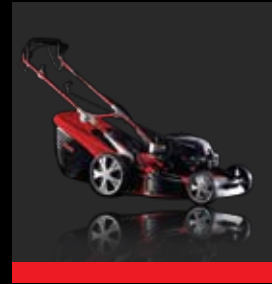
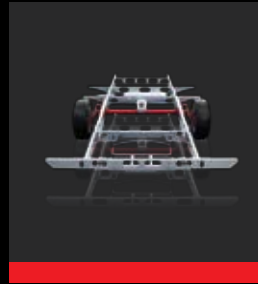

AL-KO EURO AXLE SYSTEM

AL-KO'S 25 YEAR UK MARKETPLACE EXPERIENCE AND CONTINUED INVESTMENT IN STATE OF THE ART MANUFACTURING PROCESSES HAS CREATED THE EURO AXLE FOR CARAVAN CHASSIS. THE AXLE HAS A RANGE OF FEATURES TO IMPROVE STRENGTH, STABILITY AND ROAD HOLDING TO PROVIDE A SAFER AND MORE COMFORTABLE RIDE.

PRODUCT FEATURES

1. Maintenance free sealed bearing unit
2. Hexagonal Rubber Suspension Tube
3. Adjustable toe-in and camber (factory set only)
4. Strengthened stub axle

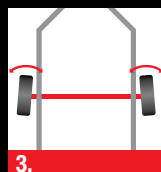
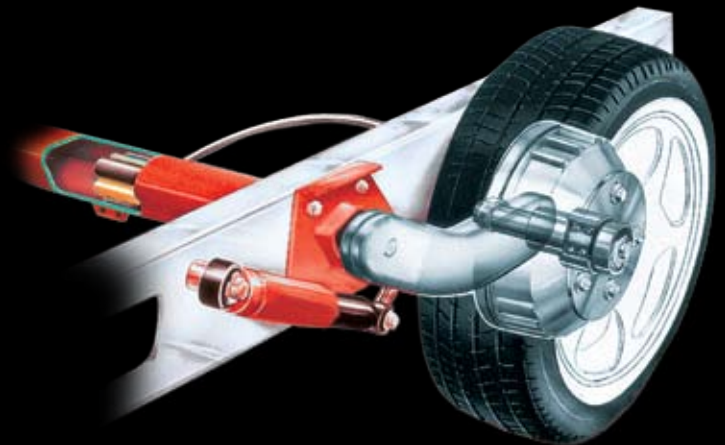

ATC TRAILER CONTROL

AL-KO AUTOMATIC TRAILER CONTROL IS THE AWARD WINNING ELECTRONIC BRAKING SYSTEM FOR CARAVANS. ATC MONITORS AND APPLIES THE CARAVAN BRAKES SHOULD THE VEHICLE EXPERIENCE UNEXPECTED INSTABILITY DUE TO HIGH WINDS, OVERTAKING HGV'S OR DURING EVASIVE MANOEUVRES.

ATC can be retro-fitted to any caravan running on an AL-KO chassis and runs off either the 12 volt 7-pin supplementary socket or alternatively off 13-pin electrics.

The AL-KO ATC trailer control system provides the assurance to drivers that, even in the most difficult of driving scenarios, the stability of their caravan and car is monitored, providing an unparalleled level of safety during the journey.



AL-KO CHASSIS

GROSS WEIGHT MAX

Unladen Weight Min



700 - 1000 kg

500 kg

1001 - 1300 kg

800 kg

1301 - 1500 kg

1000 kg

1501 - 1800 kg

1100 kg



1300 - 1600 kg

1000 kg

1601 - 2000 kg

1200 kg

2000 - 2500 kg

1600 kg



PRODUCT FEATURES

1. Retrofittable to most caravans with an AL-KO chassis
2. Maintenance free system
3. Monitors stability of both caravan and car
4. Regulates for any dangerous lateral movements
5. Immediately takes preventative action to maintain road position
6. Safely controls driving behaviour of caravan
7. Ensures more stable and balanced driving
8. Provides more assured manoeuvrability in a range of driving conditions
9. Reliable, secure and industry leading technology

“This clever stability package for caravans looks set for almost universal adoption”

Which Caravan Awards Supplement, December 2007.

“It may sound dramatic, but it’s no understatement to say that ATC could save your life”

Which Caravan Road Test, March 2008.

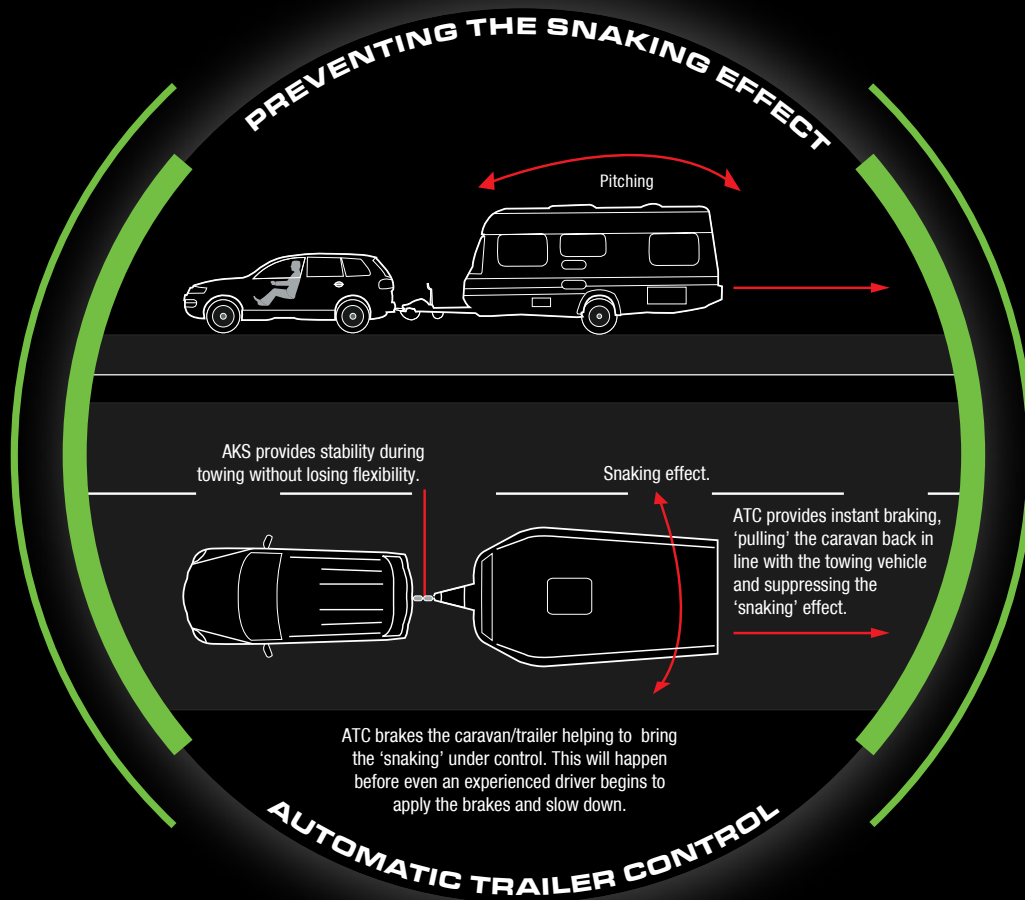

THE AL-KO FORMULA FOR OPTIMUM SAFETY

The AL-KO Formula for Optimum Safety is a combination of industry leading technology that ensures the safest possible driving conditions for Caravan owners. The formula provides total confidence and control when towing a caravan.



As an emergency system, AL-KO ATC automatically safeguards against a number of critical driving conditions. When used in conjunction with AL-KO AKS, there is no safer package for towing a caravan.

The AL-KO AKS Stabiliser device permanently suppresses small swinging and pitching movements in the trailer and increases the critical driving speed by approx 20%.

A safe driving style and correct loading combine with AL-KO technology to ensure optimum safety and unparalleled towing stability.

AL-KO SECURE

THE AL-KO SECURE WHEEL LOCK IS THE MOST SECURE ANTI-THEFT DEVICE AVAILABLE FOR ANY CARAVAN WITH AN AL-KO CHASSIS WITH ALLOY WHEELS. THE SOLD SECURE DIAMOND STANDARD WHEEL LOCK PROVIDES THE HIGHEST LEVEL OF PROTECTION TO ENSURE THAT THE CARAVAN REMAINS SAFE AND SECURE ON SITE, AT HOME OR IN STORAGE.

With over 33,000 security combinations, a 9 pin anti-pick radial lock mechanism and a registered key management system, AL-KO Secure is the most effective anti theft deterrent available for caravans.

Leading insurance companies offer significant discounts where AL-KO Secure is fitted and when combined with other AL-KO Security Devices (pages 14) even greater reductions can be achieved.

HOW THE AL-KO SECURE WHEEL LOCK IS FITTED

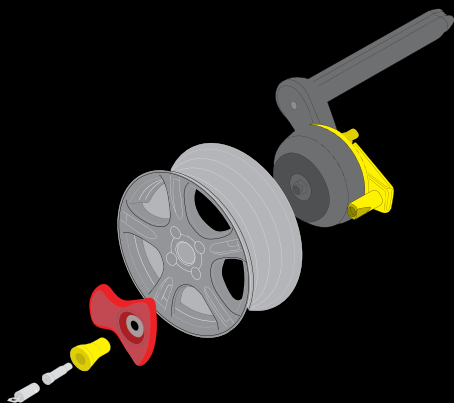

Visit WWW.AL-KO.CO.UK for advice on fitting AL-KO Secure ('Will it fit?' Section)



PRODUCT FEATURES

1. 33,000+ security combinations
2. Portable & easy to fit
3. Highly visible anti-theft deterrent
4. Sold Secure Diamond approved
5. Insurance approved
6. Registered key management system
7. 9-pin anti-pick radial lock mechanism
8. Protective Alloy Cover (also sold as optional extra)
9. AL-KO Secure Compact Kit
10. AL-KO Secure Plus Kit*
11. AL-KO Secure Premium Kit*



3.



6.



8.



9.



10.



11.



* Dealer/Service centre supply & fit only.

WHEEL DESCRIPTION & MANUFACTURER

AL-KO SECURE KIT FOR DIY FITMENT

WHEEL DESCRIPTION & MANUFACTURER

AL-KO SECURE KIT FOR DIY FITMENT



Bailey 14"
Used only by Bailey

Compact - 001907
Plus - 001916
Premium - 001941



Lunar 5514 14"
Used only by Lunar

Compact - 1289166
Plus - 1289205
Premium - Not applicable



Bailey Pageant
Used only on Bailey Pageant Series 6 & 7

Compact - only available from Bailey dealers
Plus - Not applicable
Premium - Not applicable



Popstar 14"
Used only by Swift, on some Ace Supreme & Award models

Compact - 1287648
Plus - 1287721
Premium - 1287733



Bailey Senator
Used only on Bailey Senator Series 6

Compact - Fitted As Standard
Plus - Not available
Premium - Not applicable



Quicksilver 14"
Used only by Lunar

Compact - 1287651
Plus - 1287724
Premium - 1287737



Debut 14"
Used only by Swift on a wide range of models

Compact - 1287991
Plus - 1287668
Premium - 1287738



Roven 14"
Used only by Swift

Compact - 1289106
Plus - 1289107
Premium - Not applicable



Dion 14"
Used only by Avondale

Compact - 1287649
Plus - 1287722
Premium - 1287735



RVR2 14"
Used on Conqueror 630, 650, 655 & 645 models

Compact - 1287646
Plus - 1287719
Premium - 1287731



Intra 6044 14"
Used by Hymer on some Eriba-Nova models.

Compact - 1287653
Plus - 1287713
Premium - 1287740



Salida 14"
Used only by Lunar

Compact - 1287650
Plus - 1287723
Premium - 1287736



Intra 6155 15"
Used by Hymer on some Eriba-Nova models.

Compact - 1287654
Plus - 1287714
Premium - 1287741



Mirage 14"

Compact - 1287644
Plus - 1287717
Premium - 1287729

Mirage 15"
Both used by Swift on a wide range of models.

Compact - 1287645
Plus - 1287718
Premium - 1287730



Challenger 14"

Compact - 1287992
Plus - 1287996
Premium - Not applicable



Rimfire 14"

Compact - 1287993
Plus - 1287997
Premium - Not applicable

Challenger 15"
Both used only by Swift on Challenger & Conqueror models.

Compact - 1287652
Plus - 1287726
Premium - 1287739

Rimfire 15"
Both used only by Swift on GTS, Vogue, Cameo & Spectrum models.

Compact - 1287994
Plus - 1287988
Premium - Not applicable



Hawk 14"

Compact - 1287647
Plus - 1287667
Premium - 1287728



Star 14"

Compact - 1287643
Plus - 1287720
Premium - 1287732

Hawk 15"
Both used by various manufacturers; Coachman, Vanmaster, Fleetwood.

Compact - 1287990
Plus - 1287725
Premium - 1287734

Star 15"
Both used by Swift on a range of models.

Compact - 1287995
Plus - 1287999
Premium - Not applicable



Swift Storm 14"

Compact - Only available from Swift Dealers
Plus - Not applicable
Premium - Not applicable

Swift Storm 15"

Compact - Only available from Swift Dealers
Plus - Not applicable
Premium - Not applicable

AKS 3004

THE AKS 3004 STABILISER EFFICIENTLY AND EFFECTIVELY SUPPRESSES THE INITIAL SIGNS OF VEHICLE INSTABILITY AND SNAKING MOVEMENTS OF THE CARAVAN OR TRAILER.

Made from low-wear material, four specially engineered friction pads surround the towball and continue to ensure optimum friction damping.

Fitment of the AKS 3004 stabiliser significantly improves the smoothness of a journey and provides the driver with the confidence and control required to handle critical driving situations such as high cross winds and overtaking HGV's more effectively.



OPTIONS

Available as a single product or triple pack option, containing Extended Neck Towball, AKS Security Device and Safety Ball. Visit www.al-ko.co.uk for more information.

COMPLEMENTARY PRODUCTS

Deluxe Hitch Cover
Tow Ball Cover
Soft Ball
Extended Neck Towball
Security Devices (page 14)
Removable Handle Suitable
For 4x4 Vehicles (see above right)



PART NO.	1286786 (Triple Pack)
Weight Capacity - GVW	200 kg Min.
Weight Capacity - GVM	3000 kg Max.
Max Nose Load	100 kg

PRODUCT FEATURES

1. Easy to use and simple to fit - one-handed lever action
2. Four special friction pads effectively suppress snaking & pitching
3. Safe Towing - Safety fitment indicator shows correct coupling of AKS to your towing vehicle
4. Reliability - Safety indicator provides easy monitoring of wear on the towball and front / rear friction pads
5. Additional wear control indicates wear on left / right friction pads
6. Secure - integrated brackets to allow fitment of AL-KO Security Device
7. Weight saving design - Lightweight, compact alloy construction (only 4.2 kg). Built for long life and lower resistance to corrosion
8. High weight load - maximum capacity 3000 kg
9. Universal Model - fits most chassis* †
10. Friction pads are available as spares if required

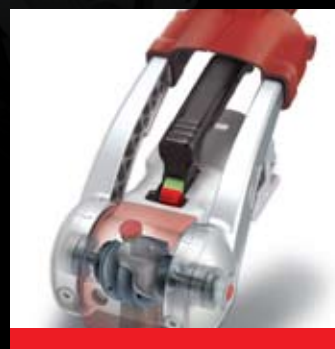

* May not be suitable for use with overrun devices which can revolve above 25 degrees or BPW overruns fitted with gas strut handbrakes from 2001 model year onwards. If in doubt about usage consult your supplier.

AKS 1300

THE AKS 1300 IMPROVES STABILITY BY UP TO 30% AND PROVIDES A MORE CONTROLLED AND COMFORTABLE RIDE.

The AKS 1300 is easy to use, featuring two easy-change friction pads, which can be monitored through the wear indicator window.

All AL-KO stabiliser parts are engineered in galvanised steel, are tested to the highest levels and exceed a 50,000 km lifespan.

The AL-KO AKS 1300 Stabiliser has been developed for caravan and trailer applications to a maximum weight capacity of 1360 kg.

Visit WWW.AL-KO.CO.UK for more information;

OPTIONS

Available as a single product or triple pack option, containing Extended Neck Towball, AL-KO Security Device & Safety Ball.

COMPLEMENTARY PRODUCTS

Deluxe Hitch Cover
Tow Ball Cover
Soft Ball
Extended Neck Towball
Security Devices (Page 14)
Removable Handle suitable for 4x4 vehicles (see page 7)



PART NO.	1385110 (Triple Pack)
Weight Capacity - GVW	180 kg Min.
Weight Capacity - GVW	1360 kg Max.
Max Nose Load	100 kg

PRODUCT FEATURES

1. Proven to improve towing stability by 30%
2. Easy to use - simple lever action
3. Safe towing - safety fitment indicator shows correct coupling of AKS to your towing vehicle
4. Towball and coupling mechanism wear indicator
5. Light and compact design, and built for long life - galvanised and corrosion resistant
6. Retro-fit Security Device available separately
7. High weight load - maximum capacity 1360 kg
8. Universal model - fits most chassis* †
9. Friction pads are available as spares if required



* May not be suitable for use with overrun devices which can revolve above 25 degrees or BPW overruns fitted with gas strut handbrakes from 2001 model year onwards. If in doubt about usage consult your supplier.

OCTAGON SHOCK ABSORBERS

THE INNOVATIVE AL-KO OCTAGON SHOCK ABSORBERS PROVIDE SUPERIOR LEVELS OF RIDE COMFORT AND ROAD HOLDING CHARACTERISTICS, WHILST IMPROVING GENERAL STABILITY OF THE CARAVAN AND MAKING YOUR JOURNEY MORE ENJOYABLE.

Designed specifically to complement the AL-KO Euro-Axle, the Octagon Shock Absorbers are available as a simple do-it-yourself retro-fitment kit.

Our range of shock absorbers covers both Single and Tandem Axle caravans up to a maximum weight of 3500 kgs.

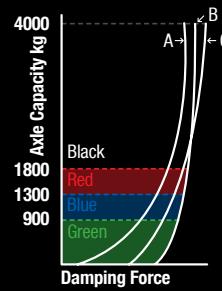

The Hysteresis Diagram left demonstrates the improved damping performance provided by the AL-KO Octagon Shock Absorber on a single axle chassis.

A-Damping curve AL-KO hexagonal rubber suspension axle

B-Damping curve of previous dampers

C-Optional curve of AL-KO Octagon damper

COMPLEMENTARY PRODUCTS

AL-KO ATC Anti-Snake System
AL-KO AKS Stabiliser



PART NO.	601206
Single Axle Range	1301 - 1800 kg
Tandem Axle Range	2601 - 3500 kg
Net Weight	1.3 kg



PRODUCT FEATURES

1. Designed exclusively for Euro-Axles
2. Complete retro-fit kit for simple installation
3. Four weight ranges for optimum damping
4. Colour coded for easy identification
5. Improved ride comfort and road holding
6. Please note: Tandem Axle Caravans require two sets of Octagon Shock Absorbers.

PART NO.	601204	601205	601207
Colour	Green	Blue	Black
Single Axle Range	Up To 900 kg	901 - 1300 kg	1801 - 4000 kg
Tandem Axle Range	Up To 1600 kg	1601 - 2600 kg	3501 - 7500 kg
Net Weight	1.3 kg	1.3 kg	1.5 kg

SPARE WHEEL CARRIER

PERHAPS THE MOST IMPORTANT SPARE THAT A CARAVAN OR TRAILER SHOULD CARRY IS THE SPARE WHEEL, THE PROBLEM IS WHERE TO STOW IT. AL-KO CAN PROVIDE THE IDEAL SOLUTION; A SPARE WHEEL CARRIER THAT IS EASY TO FIT, EASY TO USE, AND ZINC COATED TO PROVIDE ALL WEATHER PROTECTION.

The position of the carrier, within the chassis frame, and close to the axle is the ideal location with regard to weight distribution. There are four versions of the AL-KO spare wheel carrier to cover caravans with chassis member widths between 1050-1815mm. To determine which model is suitable for your caravan please refer to the 'which carrier is right for me?' section (below).



PART NO.	EXTERNAL FRAME DIMENSION A (MM)	WEIGHT KG
209 550	1050-1250	6.4
241 859	1265-1515	6.8
1287180*	1410-1715	7.5
241 860	1510-1815	7.7

* This carrier is pre-assembled

PRODUCT FEATURES

1. Enables additional storage space inside the caravan.
2. Zinc plated for all weather protection.
3. Carrier can be fitted for left or right hand operation.
4. Ideal location provides optimum weight distribution.
5. 4 versions to fit most caravan chassis.
6. Provision for securing with a padlock.
7. Meets with ADAC and DCC recommendations.
8. No TUV test or TUV approval is required for AL-KO chassis with the relevant holes.



RETROFITTING ACCESSORY KIT EH2

Part No. 294284 consisting of:
 2 mounting plates (24) Part No. 209499
 4 Hexagon screws (25) Part No. 700460
 4 Hexagon nuts (26) Part No. 700645



WHICH CARRIER IS RIGHT FOR ME ?

Step 1 - Measure distance between the chassis members and refer to figure 1 for correct part number.

Step 2 - Check which tyre size is fitted to your caravan (eg. 195 R13).

Step 3 - Measure the distance marked 'X' on the actual caravan chassis main member. (refer to figure 2).

Step 4 - Refer to figure 3 to check Dim 'X' against maximum tyre size suitable for that particular caravan/spare wheel carrier configuration.

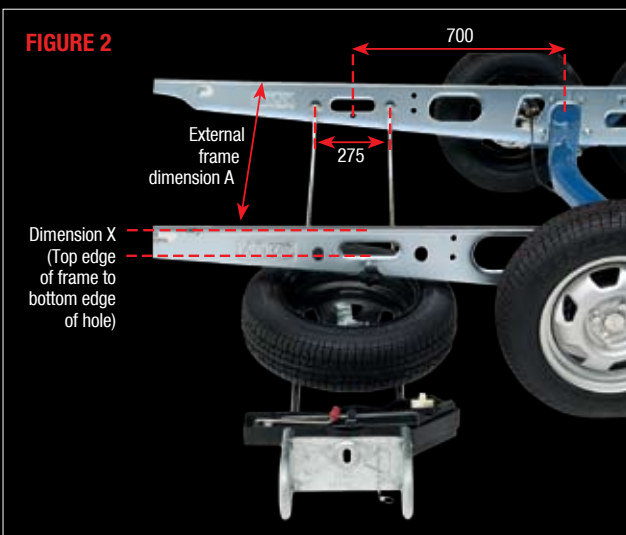

FIGURE 1

PART NO.	DESIGN	TYPE	EXTERNAL FRAME DIMENSION A (MM)	PACKAGING UNIT	WEIGHT KG
209 550	EH1	A	1050-1250	49	6.4
241 859	EH1/BR	D	1265-1515	49	6.8
1287180*	N/A	N/A	1410-1715	N/A	7.5
241 860	EH1/BR	E	1510-1815	49	7.7
294 284	Retrofitting accessory kit			20	1.85

* This carrier is pre-assembled

FIGURE 3

DIM X (mm)	MAXIMUM TYRE SIZE FOR 209550	MAXIMUM TYRE SIZE FOR 241859/241860/1287180
75	155 R13	175 R13, 175 R14, 175/70 R14
85	165 R13	185 R13, 185 R14
95	175 R13, 175 R14, 175/70 R14	195 R13, 195 R14, 195/70 R14
105	185 R14	205/70 R14, 205/70 R15
115	195/70 R14	205/70 R14, 205/70 R15
125	205/70 R14, 205/70 R15	

JOCKEY WHEELS

AL-KO JOCKEY WHEELS ARE DESIGNED FOR STABILITY, DURABILITY, EASE OF OPERATION AND LONG SERVICE LIFE. THEY ARE AVAILABLE IN A VARIETY OF MODELS, WITH A RANGE OF INNOVATIVE FEATURES TO SUIT YOUR PERSONAL CARAVANNING NEEDS.

All AL-KO Jockey Wheels are removable and stow neatly on the A-Frame when the caravan is being towed. AL-KO Jockey Wheels are hot dipped galvanised preventing corrosion and ensuring durability. They incorporate a thrust bearing which greatly reduces the effort required to manoeuvre the caravan.

THE PREMIUM JOCKEY WHEEL

The Premium Jockey Wheel is designed for use with motorised caravan movers and features extra wide, grooved rubber tyres, swing arm suspension and an integrated load indicator to gauge the noseweight of the caravan. This saves time and effort preparing for your journey.

Visit www.al-ko.co.uk for more information and to view our range of complementary products.

PART NO.	1552197
Static load capacity	300 kg Max.
Dynamic load capacity	180 kg Max.
Corrosion protection	Galvanised
Tyre	230 x 80 mm solid rubber
Wheel bearings	Friction bearings
Net weight	9.8 kg

COMPLEMENTARY PRODUCTS

- Clamps
- Wheel Chocks
- Easy Pull Coupling Aid
- Manoeuvring Handle

PREMIUM JOCKEY WHEEL - FEATURES

1. Integrated Wheel Nose Load Display saves time and effort
2. Broad, grooved rubber wheel
3. Integrated swing arm suspension
4. Detachable wheel
5. Removable, ergonomic crank handle
6. Thrust bearing and low friction crank ensures smooth and easy operation
7. High-quality corrosion protection

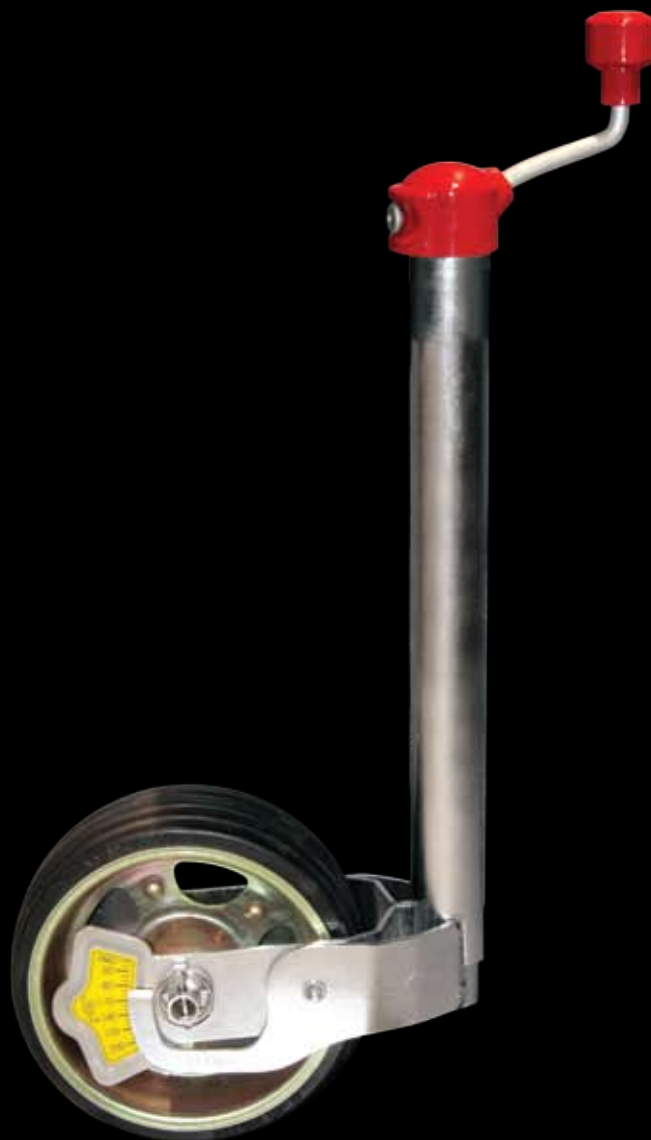

The Premium Jockey Wheel is recommended for use with the New AL-KO AMS Mammot Caravan Manoeuvring System





DESCRIPTION	PLUS JOCKEY WHEEL (150 KG STAT. CAP)	PLUS JOCKEY WHEEL (300 KG STAT. CAP)	COMPACT JOCKEY WHEEL (150 KG STAT. CAP)
PART NO.	1222436	1222437	1222433
Static load capacity	150 kg Max.	300 kg Max.	150 kg Max.
Dynamic load capacity	90 kg Max.	180 kg Max.	90 kg Max.
Corrosion protection	Galvanised	Galvanised	Galvanised
Crankshaft	Thrust bearings	Thrust bearings	Thrust bearings
Wheel rim	Steel	Steel	Plastic
Tyre	200 x 50 mm solid rubber	200 x 50 mm solid rubber	200 x 50mm soft rubber
Wheel bearings	Friction bearings	Friction bearings	Friction bearings
Net weight	5 kg	7 kg	4.8kg



DESCRIPTION	PLUS JOCKEY WHEEL PLASTIC WHEEL/RUBBER TYRE (150 KG STAT. CAP)	PLUS JOCKEY WHEEL STEEL WHEEL/PNEUMATIC TYRE (200 KG STAT. CAP)	PLUS JOCKEY WHEEL PLASTIC WHEEL/H.DUTY PLASTIC TYRE (150 KG STAT. CAP)
PART NO.	1222435	1222438	1222221
Static load capacity	150 kg Max.	200 kg Max.	150 kg Max.
Dynamic load capacity	90 kg Max.	120 kg Max.	90 kg Max.
Corrosion protection	Galvanised	Galvanised	Galvanised
Crankshaft	Thrust bearings	Thrust bearings	Thrust bearings
Wheel rim	Plastic	Steel	Plastic
Tyre	215 x 65 mm soft rubber	260 x 85 mm pneumatic	240 x 70mm soft rubber
Wheel bearings	Friction bearings	Friction bearings	Friction bearings
Net weight	5 kg	5 kg	5 kg

SIDE LIFT JACK

THE AL-KO SIDE LIFT JACK IS THE PERFECT SOLUTION FOR LIFTING A CARAVAN TO CHANGE A WHEEL, OR TO FIT THE AL-KO SECURE WHEEL LOCK. THE SIMPLE TO USE, SMOOTH WINDING OPERATION OF THE JACK ALLOWS THE CARAVAN TO BE LIFTED EASILY WITH THE MINIMUM AMOUNT OF EFFORT.

There are two versions of the Side Lift Jack available, one suitable for vehicles up to 1600 kg and one for 1601 kg - 2000 kg weight ranges. The kit includes a set of support brackets for fitment to both sides of the caravan and all necessary fixings and operating instructions.

The Jack can be used on any AL-KO Chassis built from 1980 onwards. Since 1992 AL-KO have been providing pre-punched holes in the chassis member to attach the support brackets contained in the Side Lift Jack kit. Vehicles older than 1992 will need to have the holes drilled in the chassis as detailed in the Jack instruction handbook.

Visit www.al-ko.co.uk for more information and to view our range of complementary products.

COMPLEMENTARY & ALTERNATIVE PRODUCTS

- Wheel Chocks
- 800kg Side Lift Jack Replacement Bracket Kit (Part No. SPR004)
- 1000kg Side Lift Jack Replacement Bracket Kit (Part No. 1552998)



PART NO.	DESCRIPTION	MAX STATIC LOAD	COLLAPSED HEIGHT	EXTENDED HEIGHT	WEIGHT
235977	Vehicles up to 1600 kg	800 kg	85 mm	375 mm	4.2 kg
1389235	1601 kg - 2000 kg	1000 kg	85 mm	375 mm	5.5 kg

Both products come complete with storage bag.



Part No. 246059 - 800kg Side Lift Jack Kit with Plastic Carry Box

PRODUCT FEATURES

1. Model shown - Vehicles up to 1600 kg
2. Model shown - Vehicles from 1601 - 2000 kg
3. Easy to install & operate
4. Brackets fit to both sides of caravan
5. Mounting bracket design ensures correct positioning and operation
6. Can be lowered to 85 mm
7. Can be raised to 375 mm



1.



2.

SECURITY DEVICES

AL-KO SECURITY DEVICES PROVIDE A SUBSTANTIAL DETERRENT AGAINST THE THEFT OF THE CARAVAN OR TRAILER.

The AL-KO Security Devices are designed to lock over the coupling handle. Fitting the supplied Safety Ball into the coupling head when the Security Device is applied, prevents the caravan or trailer from being coupled to another vehicle.

The lock is manufactured from high density steel and is TUV approved.

Visit www.al-ko.co.uk for more information and to view our range of complementary products.

COMPLEMENTARY PRODUCTS

- Deluxe Hitch Cover
- AL-KO Padlocks



PART NO.	DESCRIPTION	WEIGHT
249818A	AL-KO Security Device for AK 160 (35mm) Coupling Head	1.5 kg
1385877	AL-KO Security Device for AK 160/300 (50mm) Coupling Head	1.5 kg
1385878	AL-KO Security Device For AKS 1300 Stabiliser	1.5 kg
1385879	AL-KO Security Device For AKS 2000/2500/2700 Stabilisers	2.2 kg
1285810	AL-KO Security Device For AKS 2004/3004 Stabilisers	1.5 kg
1224081	AL-KO Security Device - Universal for all 50mm Ball Couplings (see right)	1 kg



Part No. 1224081
Universal Security Device

AKS HITCH LOCK PRODUCT FEATURES

1. Safeguards against unauthorised coupling and uncoupling
2. Safeguards against theft of the coupling head or stabiliser
3. Can remain fitted during any journey (not for AKS 2000 manufactured before 1992)
4. Extremely robust and attractive design
5. Provides a visual theft deterrent
6. Can be fitted whilst trailer/caravan is still coupled to tow vehicle, e.g. when parked

CORNER STEADIES

AL-KO STEADIES ARE EASY TO OPERATE AND PROVIDE A STABLE FOOTING ON WHICH TO LEVEL YOUR CARAVAN. COMPLEMENT WITH THE AL-KO BIGFOOT TO ENSURE A SURER FOOTING.

PART NO.	1221694
Load bearing capacity	1250 kg Max.
Max. gvw of trailer	2500 kg
Finish	Hot galvanised
Net Weight	4.95 kg

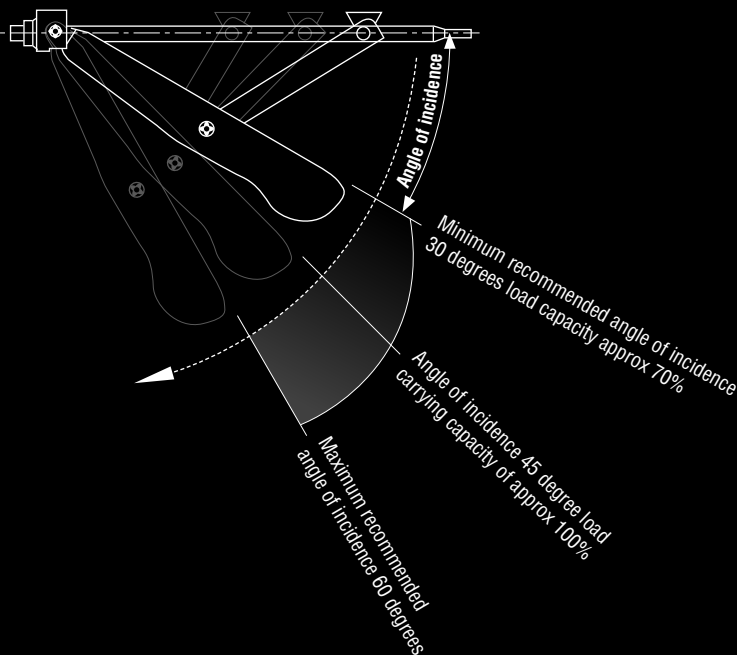

PRODUCT FEATURES

1. Easy to fit mounting brackets are provided on the chassis which allow fast and easy fitment of corner steadies.
2. Stable - AL-KO corner steadies are particularly stable due to the pressed side profiles and strong threaded spindles.
3. High Quality corrosion protection - corner steadies are almost indestructible due to a hot dip galvanised coating with a layer thickness of up to 70 µm.
4. Comfort Kit - Comprises 4 x moulded plastic tubes (2 x long & 2 x short) plus two different length socket adapters.
5. Anti-theft device - for Premium Corner Steadies 1250kg from 2006 model year.



2.



4.

Part No. 1210506



5.

Part No. 1222515



DESCRIPTION	SYSTEM CORNER STEADY - SHORT	SYSTEM CORNER STEADY - LONG	STABILFORM CORNER STEADY
PART NO.	205808	205817	267265
Load bearing capacity	800 kg Max.	800 kg Max.	1000kg Max.
Max. gvww of trailer	1300 kg	1300 kg	2000 kg
Finish	Hot galvanised	Hot galvanised	Hot galvanised
Net Weight	3.4 kg	3.6 kg	4.2 kg

BIG FOOT AND ADAPTER

AL-KO BIG FOOT™ PRODUCT FEATURES

- Secure Landing**
The AL-KO Big Foot™ with its large, reinforced landing area prevents the steady legs from sliding away or sinking and provides a firm safe base for the caravan. The support foot has a maximum load bearing capacity of 1250kg.
- Reduced space requirement**
During driving the AL-KO Big Foot™ locks against the corner steady by means of a retaining spring.
- Function**
A slot ensures that on progressive contact with the ground, AL-KO Big Foot™ functions independently by adapting to the lie of the land.
- Set of 4 robust platform feet (200x180mm) that automatically lower/raise when corner steady is operated.



PART NO.	1212458
Suitable for	Standard 'Stable-form' and Premium Corner Steadies
Finish	Plastic PA Grey
Weight	2.5kg per set



45MM ADAPTER FOR AL-KO AL-KO BIG FOOT™

The adapter enables Big Foot™ to get 45 mm closer to the ground. To prevent the AL-KO big foot from catching the ground, a check must be carried out for each caravan to determine if the clearance is adequate.

Set of 4 adapters that can be fitted to the AL-KO Big Foot to provide an additional 45 mm height to corner steady.

PART NO.	1213899
Suitable for	Standard 'Stable-form' and Premium Corner Steadies
Finish	Plastic PA Grey
Weight	2.5kg per set



COMPLEMENTARY PRODUCTS

WHEEL CHOCKS

Available in a wide range of sizes and specifications. Caravans over 4000kg require two chocks. See www.al-ko.co.uk for full range.



PART NO.	249422	1213314	1221515
Material/finish	Black plastic	Black plastic	Black plastic
Wheel load per chock max.	800kg	5000kg	6500kg
Static tyre radius max.	up to 310 mm	up to 460 mm	up to 530 mm
Min. test force on the chock	10 140 N	65 000 N	84 500 N
Net weight	0.2kg	1.85kg	2.9kg

DELUXE HITCH COVER

Manufactured from high quality, weather resistant, breathable material. All hitch covers are colour fast. Please check below for the correct hitch cover for your stabiliser or coupling.



PART NO.	1287002	1287284
Suitable for	AKS 2004/3004	AKS 1300
Net Weight	0.190 kg	0.190 kg

PROTECTIVE COVER FOR AL-KO SECURE

Protect your alloy wheels with this high quality plastic cover - available in a range of sizes to suit your Secure product.

PART NO.	AL-KO SECURE TO SUIT	PART NO.	AL-KO SECURE TO SUIT
1552613	Bailey 14" Alloy (Insert No.1)	1552622	Rimfire 14" Alloy (Insert No.16)
1552614	Hawk 14" Alloy (Insert No.2)	1552623	Rimfire 15" Alloy (Insert No.17)
1552615	Star 14" Alloy (Insert No.3)	1552753	Star 15" Alloy (Insert No.18)
1552616	Mirage 14" Alloy (Insert No.5)	1552624	Hawk 15" Alloy (Insert No.19)
1552617	Challenger 15" Alloy (Insert No.6)	1552743	Bailey Pageant 14" Alloy (Insert No.20)
1552618	Salida 14" Alloy (Insert No.8)	1552625	Avondale 14" Alloy (Insert No.21)
1552619	Quicksilver 14" Alloy (Insert No.11)	1552744	Bailey Senator 14" Alloy (Insert No.22)
1552620	Intra 15" Alloy (Insert No.13)	1552626	Roven 14" Alloy (Insert No.23)
1552621	Challenger 14" Alloy (Insert No.15)	1552627	Lunar 5514 14" Alloy (Insert No.24)



SOFT BALL

Provides effective shin protection should you accidentally walk into the towball. Available in three colours.



PART NO.	1385053	1310913	1337726
For Towballs	with 50 mm ball	with 50 mm ball	with 50 mm ball
Colour	Red	Black	Blue
Net weight	0.055 kg	0.055 kg	0.055 kg

EXTENDED NECK TOW BALL KIT

Extended neck towball kit for use with AL-KO stabilisers.

PART NO.	1385401
Description	Extended neck tow ball - AKS
Trailer MGW	2000
Nose Load (kg)	150
EC Approval No.	e1*1118*00
D Value (kN)	17
Weight (kg)	2



TOW BALL COVER

Robust, black plastic towball cover for use with extended neck towball.

PART NO. 585208



JOCKEY WHEEL MANOEUVRING HANDLE

Suitable for 48mm diameter Jockey Wheels.

PART NO.	1210182
Finish	Plastic red RAL 3003
Net weight	0.2kg
Part No.	1210867



AKS 3004 Stabiliser Handle

Part No. 1552795



4x4 Retro-Fit Stabiliser Handle for AKS2004/3004

Specially designed handle for 4x4 vehicles. Designed to aid stabiliser operation when used with 4x4 towing vehicles with rear mounted spare wheel carriers.

Part No. 1287287



JOCKEY WHEEL CLAMPS

Wide range of Jockey Wheel Clamps. See www.al-ko.co.uk for full range.



PART NO.	205318	249804	249859	1335092
Static load bearing capacity	200kg	300kg	500kg	300kg
Corrosion protection	Hot galvanised	Hot galvanised	Hot galvanised	Hot galvanised
Net weight	0.8kg	1.0kg	2.0kg	2.42kg