

# **AL-KO** Sensabrake™



## **Sensabrake™ IN CAR KIT** **Installation & Operating Instructions**

**V1.1/012010/ICSAB**

# **AL-KO INTERNATIONAL**

ABN 96 003 086 813

*FOR DETAILS OF YOUR NEAREST AL-KO AUTHORISED SERVICE AGENT  
PLEASE CONTACT OUR STATE OFFICES AS LISTED BELOW:*

## **VICTORIA**

*State Manager – Mr. Gerard L'Huillier*

67-91 NATHAN ROAD,  
DANDENONG STH, VICTORIA 3175  
TELEPHONE: (03) 9767 3700  
FACSIMILE: (03) 9792 0877

## **NEW SOUTH WALES**

*State Manager – Mr. Leo Sargent*

14 TOOHEY ROAD,  
WETHERILL PARK, NEW SOUTH WALES 2164  
TELEPHONE: (02) 8784 9400  
FACSIMILE: (02) 9725 4557

## **QUEENSLAND**

*State Manager – Mr. Mike Jovicic*

13 UNION ROAD, YATALA, QUEENSLAND 4207  
TELEPHONE: (07) 3386 6300  
FACSIMILE: (07) 3386 6399

## **NEW ZEALAND**

*Manager – Mr. Mark Lovell*

1 AIRPARK DRIVE, AIRPARK OAKS  
MANGERE, AUCKLAND  
TELEPHONE: (09) 255 5611  
FACSIMILE: (09) 255 5612

---

This information **MUST** be distributed with the AL-KO Sensabrake™ trailer braking system  
and be kept with the towing vehicle for future reference.

PLEASE READ WIRING INSTRUCTIONS AS IMPORTANT CHANGES HAVE BEEN MADE.

**The AL-KO Sensabrake™ EVO Controller incorporates a number of unique features designed to maximise the performance of your braking system.**

## **Auto Detect**

The AL-KO Sensabrake™ EVO incorporates an 'Auto Detect' function that enables it to identify which type of braking system has been connected and alters its electronic signal automatically in order to achieve maximum brake performance.

When in Electric Brake mode (if installed) the LED on the mouse is orange. The intensity will increase as braking increases.

In AL-KO Sensabrake™ mode the LED on the mouse is green and will change to orange when brakes are applied. The intensity will increase as braking increases.

## **IMPORTANT!**

If changing between trailers utilising varying actuator types (i.e. AL-KO Sensabrake™ to Electric), the tow vehicle power supply will need to be turned off then turned on again to enable trailer detection.

## **Controller Components**

### ***Brake Pad***

The patented AL-KO Sensabrake™ Pad is mounted onto the brake pedal of the tow vehicle. A pressure sensitive film incorporated into the pad measures the force being applied in a braking situation and converts this into a variable voltage signal.

### ***Mouse***

The AL-KO Sensabrake™ Mouse is to be mounted in the cab of the towing vehicle within easy reach of the driver.

### **The mouse serves a number of functions:**

***Panic Button*** - The panic button provides an antisway function. Should the trailer get into a sway the panic button is pressed, applying a light braking force to the trailer independent to the towing vehicle. The brakes will be applied lightly for 3 seconds only and should assist in the straightening of the trailer. The tow vehicle & trailer stop lights are also activated.

***Variable Gain Control*** - Enables the driver of the towing vehicle to set the amount of trailer braking from within the cab. Ideally the gain should be set so as the towing vehicle and trailer brake together.

Excessive braking of the trailer will result in premature wearing of the trailers brake shoes/pads.

## EVO Controller (ECU)

The AL-KO Sensabrake™ EVO continually monitors the state of the electric system to ensure safe operation. The early detection of potential faults are all continually monitored with the driver informed of any such fault through the AL-KO Sensabrake™ mouse (audible and visual signals).

## Wiring Loom

The AL-KO Sensabrake™ Wiring Loom has been specially designed to simplify the installation process and is outlined in figure 1.

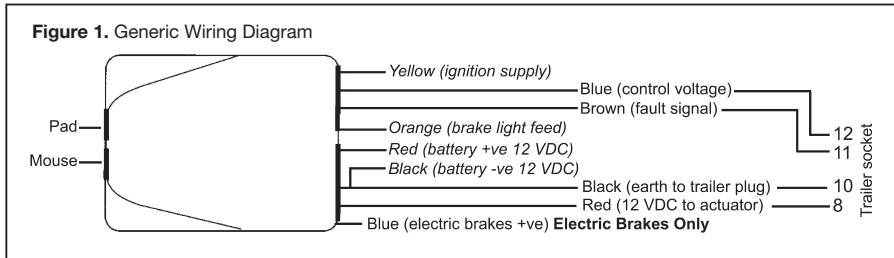

## INSTALLATION

### Towing Vehicle

**Note:** It is recommended that all in-vehicle electrical work is undertaken by a registered auto electrician, and that the bare copper conductors to pins 8, 10, 11, 12 are not soldered before fitting.

### IMPORTANT!

1. The EVO must be installed with a 12 volt negative ground system
2. The EVO must be mounted away from all other electronic control devices e.g. electric throttle control.
3. Route all wires as far from the radio antenna as possible to reduce AM interference.

It is critical that when installing the AL-KO Sensabrake™ EVO Controller that the factory supplied wiring loom is used.

4. Should additional wire be required make sure that it is of similar or larger gauge than supplied. **Under no circumstances** should wire thinner than the factory supplied loom be used as this may affect product performance and void the warranty.
5. The collection of water inside the electrical trailer connection will reduce the life of the connector and may result in inadequate or intermittent braking. To minimise corrosion build up inside the connector, it is suggested that an appropriate corrosion preventative compound be applied to conductive surfaces. Refer to maintenance section.

## MAINTENANCE:

The AL-KO Sensabrake™ is an intelligent trailer braking system that has onboard diagnostic software. Should the system detect a fault, the operator will be informed via a visual and audible alarm inside the tow vehicle. This does not however mean that the system should not regularly be maintained.

### **It is suggested that before each use:**

1. Check the brake fluid level of the AL-KO Sensabrake™ system.
2. Check all electrical leads and connectors for broken wires, damaged or corroded connectors etc.

**It is suggested that an appropriate corrosion preventive compound be periodically applied to all exposed wiring and connectors.**

3. Always ensure the trailer plug and socket are kept in good working condition. They must be kept clean and dry to prevent electrical leakage that may cause the trailer brakes to provide inadequate or intermittent braking.
4. Brake fluid should be replaced annually or more frequently in heavy use.

**WARNING:** When not in use over extended periods of time, please ensure the actuator is activated periodically (approximately every four weeks) to ensure moving components remain in good operating condition and seals remain lubricated. Failure to do so may result in incorrect product performance and could result in serious damage or injury.

## FAULT SIGNALS

*Constant beeping and flashing*

**Situation:** Actuator pressure has not been reached, trailer disconnected while ignition still on, low voltage alarm, or excessive moisture in trailer socket causing short circuit.

*Four beeps/flashes at one second intervals followed by rest period of 4 seconds (repeats for 10 minutes)*

**Situation:** Compressor has been operating for more than 200 seconds continuously (will not operate for 10 minutes while cooling).

## VERIFYING ELECTRICAL INSTALLATION

After completion of electrical installation it is important to verify correct installation using the following procedure.

- a) With the engine RUNNING measure the voltage at the tow vehicle battery.

- b) With the engine RUNNING and the trailer connected, apply the trailer brakes so as to engage operation of the trailer mounted compressor. While the compressor is RUNNING measure the actuator supply voltage at the trailer plug across pin 8 & pin 10.
- c) Maximum voltage drop from the battery to the trailer plug must not exceed 1.5 volts. Refer to figure 2 for pin layout.
- d) If the battery voltage is less than 12 volts the battery should be tested, and all electrical connections between the battery, EVO controller, and trailer plug checked for correct operation and repaired or replaced where necessary.

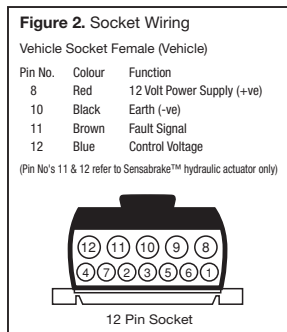

*Refer to figure 2 for pin layout.*

**Note: Vehicles fitted with fault feedback systems or digital signaling may require isolation relays fitted to the EVO ignition and brake light supplies. Power and earth supplies must come direct from the battery. This should ensure that the AL-KO Sensabrake™ EVO controller is independent of the vehicles electronics.**

## TESTING

### Hydraulic AL-KO Sensabrake™ actuator only

After the Initialisation sequence has been completed, test the system set-up as follows:

- a) Turn on the ignition. The mouse will produce the 'fault signal' indicating that a sufficient pressure has not yet been achieved in the actuator. This signal will last for approximately 30 - 40 seconds until a working pressure has been reached. The compressor will however remain on after the signal has stopped, until working full pressure has been achieved (approx. 90 -100 seconds).
- b) Once the 'fault signal' has stopped, wait a further 60 seconds before undertaking brake proportionality testing. Find an appropriate stretch of road where brake testing can be undertaken without the disruption of other road users.
- c) Set the gain control slider on the mouse to the middle position.
- d) Driving at approximately 50km per hour apply the brakes. Take note of the braking proportionality between the towing vehicle and the towed vehicle. If they are not similar then adjust the gain slider to the right for **more trailer braking** or left for **less trailer braking**. If the gain slider is

set on full (+) and insufficient trailer braking occurs then repeat steps 1 and 2 in the initialisation sequence (page 6). At step 2 place less pressure on the brake pedal.

e) When proportional braking has been established the system is ready for use.

### **Electric Brakes only**

After the Initialisation sequence has been completed, test the system set-up as follows:

- a) Set the gain control slider on the mouse to the middle position.
- b) Driving at approximately 50km per hour apply the brakes take note of the braking proportionality between the towing vehicle and the towed vehicle. If they are not similar then adjust the gain slider to the right for **more trailer braking** or left for **less trailer braking**. If the gain slider is set on full (+) and insufficient trailer braking occurs then repeat steps 1 and 2 in the initialisation sequence (page 6). At step 2 place less pressure on the brake pedal.
- c) When proportional braking has been established the system is ready for use.

### **IMPORTANT!**

Please ensure trailer socket is mounted in a position that does not enable water contact or pooling around terminals.

**Under no circumstances should the trailer plug or socket be submerged under water as this may result in inadequate or intermittent braking.**

### **IMPORTANT!**

**24 Volt Vehicles:** Vehicles operating a 24 volt system must utilize the AL-KO Sensabrake™ 24-12VDC converter (Part no. 350015). Failure to do so will void any warranty claim.

### **IMPORTANT**

For Electric Brake Installation Only, a separate 7 pin socket must be used when connecting electric brakes.

Connect the LARGE blue electric brake wire to pin 5 of the 7 pin socket. The remaining 6 pins should be looped into the corresponding pins of the 12 pin socket.

**UNDER NO CIRCUMSTANCES SHOULD THE ELECTRIC BRAKE WIRE (BLUE) BE CONNECTED TO THE 12 PIN SOCKET.**

Pin No.	Colour	Function
8	Red	12 Volt Power Supply (+ve)
10	Black	Earth (-ve)
11	Brown	Fault Signal
12	Blue	Control Voltage

## INITIALISATION SEQUENCE

The object of the initialisation sequence is to establish minimum and maximum braking pressure limits based on the towing vehicles braking characteristics.

This sequence need only be undertaken during initial installation, however should braking characteristics require modification the sequence can be repeated.

### **Step 1:**

Set the Mouse gain to the minimum position (i.e. far left) and start the vehicle with panic button pressed down (simultaneously). DO NOT have your foot on the brake pedal when starting the vehicle. Two short beeps and two flashes from the mouse indicates you are in calibration mode.

### **Step 2:**

Place light pedal pressure on the brake pedal at the point that you require maximum trailer braking and press the panic button. Three beeps and three flashes indicate that the maximum brake pressure calibration has occurred correctly.

### **Note:**

If the maximum brake pressure calibration is set too high, insufficient trailer braking will occur. Repeat the initialisation sequence. At Step 2 place a lighter brake pedal pressure.

### **Note:**

All steps have 'sensible limit' checks and will revert to default values if expected values are not found.



## Wiring Description

### **Earth**

The black wire labelled “Earth” (ground) is to be wired into the towing vehicles 12 volt (-ve) terminal of the battery - at no stage should it be connected to the chassis or vehicle body.

### **12 Volt Power Supply**

The red wire labelled “Battery +ve 12 volt’ is to be wired into the towing vehicles 12 volt (+ve) terminal of the battery. The 30 amp resettable circuit breaker as supplied and fitted to the loom must also be incorporated as close as possible to the battery on this supply line.

The 30 amp circuit breaker should be secured to a **non-conductive** surface of the vehicle. The terminals must be insulated using electrical insulating tape or similar.

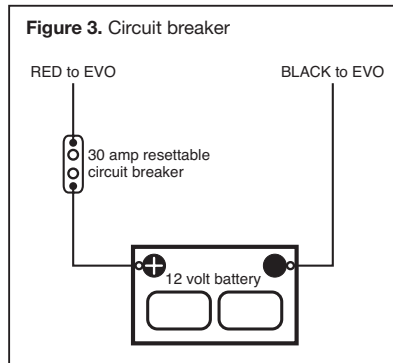

### **Ignition Supply**

The yellow wire labelled “Ignition Supply” is to be wired direct to the lighter socket supply line or similar. This power supply must only be live after the ignition is turned on and must be 12 volts.

### **Brake Light**

The orange wire labelled “Brake Light’ is to be wired into the brake light circuit between the brake light switch and the brake lights of the towing vehicle. This must be 12 volts when the brake light is activated.

## EVO Controller

It is suggested that the EVO is attached firmly under the dashboard of the towing vehicle using cable ties (or similar) so as not to interfere with the normal operation of the vehicle and so as to protect the components and connectors. This must be as far as possible from the vehicle's electronic control units including electronic throttle control units in order to prevent possible electrical interference.

## AL-KO Sensabrake™ Pad

1. Remove the brake pad rubber from the brake pedal of the towing vehicle.
2. Using the template from the back page of this manual drill the two 5.5mm holes through the brake pedal as indicated on the template.
3. Attach the AL-KO Sensabrake™ pad to the brake pedal and secure as shown in figure 4.

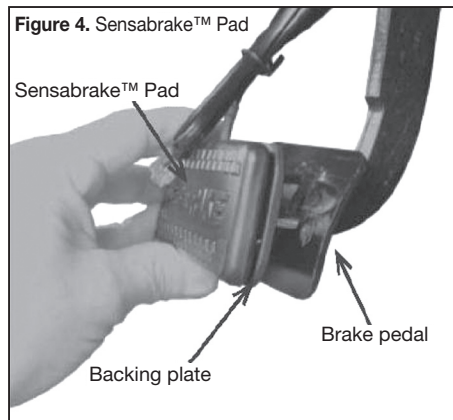

## IMPORTANT

Make sure the steel backing plate is installed between the AL-KO Sensabrake™ pad and the brake pedal!

4. Secure the Pad cable so as to prevent damage and so as not to interfere with normal operation. Excessive clamping or over tensioning may damage the cable voiding the warranty.
5. Run the cable to the EVO controller mounted under the dashboard and plug into the controller. Secure the pad cable sufficiently to ensure it does not impede the movement of the brake pedal.

## AL-KO Sensabrake™ Mouse

The Slider (Gain) Control provides additional 'instant' user adjustment of control sensitivity.

Remove the outer surface of the adhesive tape on the back of the AL-KO Sensabrake™ mouse. Firmly secure to the dashboard of the towing vehicle in a position that is within easy reach of the driver but not in a position where the panic button may be accidentally pressed. Run the cable to the EVO controller mounted under the dashboard and plug into the controller.

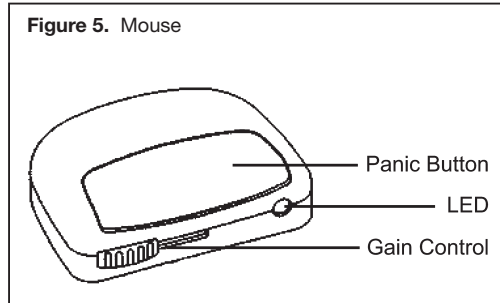

## European vehicle installations

For some late model European tow vehicles that are fitted with “fault feedback systems” there may need to be special consideration in the wiring installation. In particular, the brake light supply and ignition feed to the EVO controller from the Tow vehicle. These vehicles are likely to run a digital “Bus” system that will send an alarm signal back to the dash of the vehicle. These vehicles will need to have the brake light wired to the brake light supply from the tow vehicle via a low current draw relay. The power supply to the relays will need to come direct from the battery 12 volt + ve. The ignition supply will also need to be run through a low current draw relay as well. This will then isolate the AL-KO Sensabrake™ In Car kit to the battery supply only, therefore not interfering with the tow vehicle on board “fault feedback system”.

Selected vehicles may need to be wired using low current draw relays to the brake light and ignition supplies. Your approved AL-KO International installer will be able to advise.

## WARRANTY

### LIMITED WARRANTY AND LIMITATION OF LIABILITY

All products manufactured by AL-KO International are warranted to be free from defects in material and workmanship under normal and proper use for a period of 12 months.

No Warranty claim will be allowed unless the material or workmanship defect is found within the warranty period, properly documented by the buyer and AL-KO International is notified within 7 days of the failure.

The warranty shall not apply to products altered or utilized in a manner not approved by AL-KO International, or subjected to abuse, misuse, improper maintenance, neglect or accident.

In the event of a warranty claim, AL-KO International will repair or replace the affected product upon the products return.

The purchaser agrees that under no circumstances will AL-KO International's liability, whether based on contract, negligence, strict liability, or otherwise, exceed the buyers net purchase price, nor will AL-KO International be liable for any special, incidental, consequential or exemplary damages.

The forging of warranties will continue in effect so long as the product is serviced and maintained in accordance with AL-KO Internationals instructions and using genuine replacement parts.

### Extended AL-KO Warranty

AL-KO International will extend the warranty for a further period of 12 months (totalling 2 years) under the following conditions:

The In Car kit is installed by an AL-KO International approved installer. The vehicle owner will need to fill in the warranty section from the Actuator instruction manual and send back to AL-KO International for registration. This will need to be accompanied by a copy of the invoice for installing the In Car kit by the approved installer. This must clearly show the date of installation and the name of the approved installer.

AND the actuator has been installed by an approved OEM manufacturer.

Should these details not be returned then AL-KO International reserves the right to limit the warranty to 12 months.

**Failure to comply with the installation & verification instructions may result in premature product failure that could lead to serious injury, accident, or death and will void the product warranty.**

For warranty or service assistance contact AL-KO International on:

Australia +61 3 9767 3700  
New Zealand +64 (09) 255 5611  
Email info@alko.com.au

For technical assistance please call AL-KO International or your AL-KO Sensabrake™ supplier.

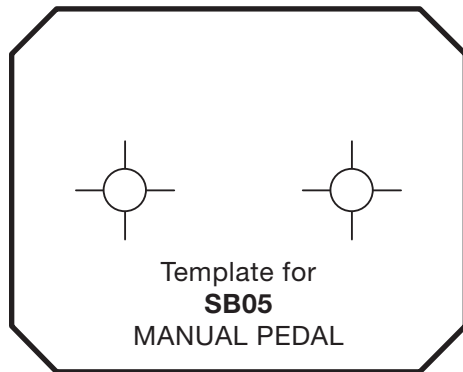
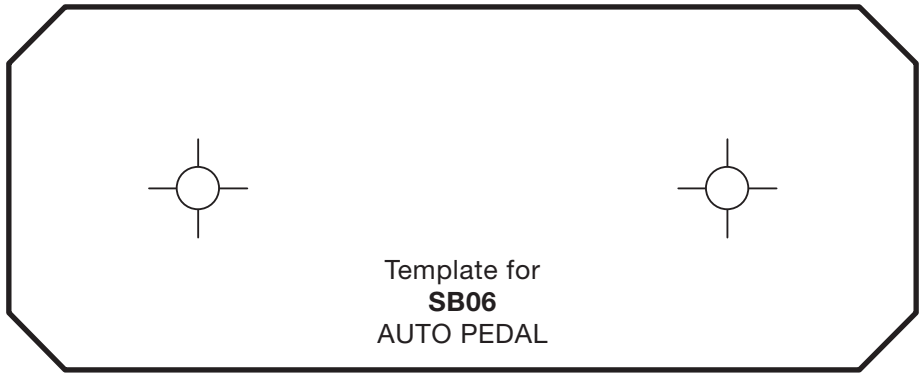



# **AL-KO** Sensabrake™

## Product Warranty Registration Card

To register your purchase, please complete the form below and return to the AL-KO address below.

Model \_\_\_\_\_ Serial No. ALK \_\_\_\_\_ Date Purchased \_\_\_\_\_ Installed by Dealer  Yes  No

Where did you learn of Sensabrake™?  Ad  Dealer  Owned before  Friend Recommended  
 Other \_\_\_\_\_

Type of tow vehicle: Make \_\_\_\_\_ Model \_\_\_\_\_

Type of trailer:  Boat  Transport  Horse  Caravan  Other \_\_\_\_\_

Prior brand if this is a replacement: \_\_\_\_\_

Average km per year towing trailer \_\_\_\_\_ Gross Vehicle Mass (GVM) of towed vehicle \_\_\_\_\_

Name \_\_\_\_\_ Address \_\_\_\_\_

City \_\_\_\_\_ State, Province \_\_\_\_\_ P/Code \_\_\_\_\_

Dealer Name \_\_\_\_\_ Dealer Address \_\_\_\_\_

City \_\_\_\_\_ State, Province \_\_\_\_\_ P/Code \_\_\_\_\_

**Return to:**

AL-KO International Pty Ltd

ABN 96 003 066 813

67-91 Nathan Road

Dandenong South Victoria 3175

Australia

Phone: 61 3 9767 3700

Fax: 61 3 9792 0877

Email: [info@alko.com.au](mailto:info@alko.com.au)

Web: [www.alko.com.au](http://www.alko.com.au)

# AL-KO

**Further information can be obtained by contacting  
AL-KO on 1800 035 603 or by visiting: [www.alko.com.au](http://www.alko.com.au)**

**AL-KO International Pty Ltd** (ABN 96 003 066 813)

VIC: 67 Nathan Road, Dandenong South, 3175

NSW: 14 Toohey Road, Wetherill Park, 2164

QLD: 13 Union Circuit, Yatala, 4207

NZ: 1 Airpark Drive, Airpark Oaks, Mangere, Auckland

**Phone (03) 9767 3700** Fax (03) 9792 0877

**Phone (02) 8784 9400** Fax (02) 9725 4557

**Phone (07) 3386 6300** Fax (07) 3386 6399

**Phone (09) 255 5611** Fax (09) 255 5612