

## 2 Overrun Devices

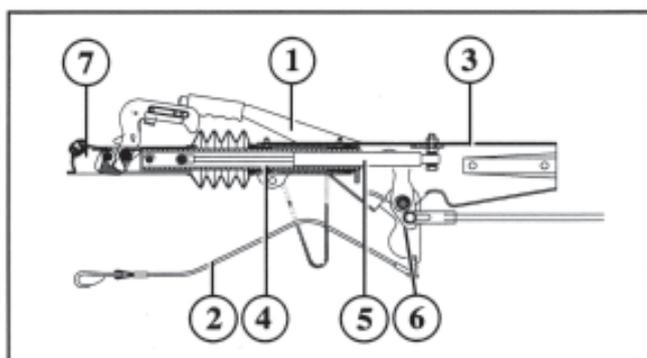
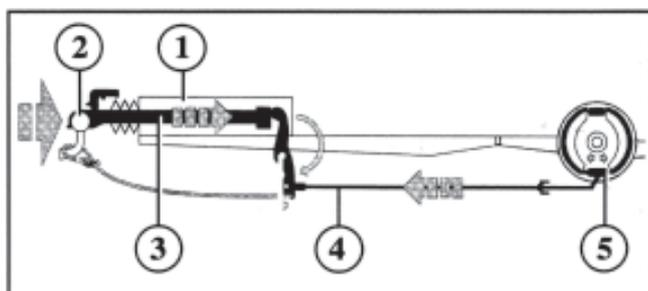

### 2.1 Function and construction of the overrun device

#### 2.1.1 Function

The overrun device (1) may be described as the control unit for the overrun braking system. Braking by the towing vehicle generates a towbar force at the coupling point (2). When the operating threshold is exceeded, the drawbar (3) is pushed in. This causes the wheel brakes (5) to operate via the linkage system (4).

#### 2.1.2 Construction

The overrun device consists of a number of assemblies:

- 1 Handbrake system
- 2 Breakaway cable
- 3 Housing
- 4 Drawbar
- 5 Damper
- 6 Overrun lever in linkage system
- 7 Coupling head

### 2.2 Maintenance

#### 2.2.1 Checking the functions

##### Handbrake

- Pull the handbrake lever on and check that it moves freely
- Check the condition of the gas strut.
- Check the condition of the overrun unit.

##### Jockey wheel and locking handle

- Check the wheel for damage
- Release the locking handle and check the thread
- Move the jockey wheel up and down
- Tighten the locking handle
- Wind the jockey wheel up and down with the crank.

##### Drawbar bearings

- Pull the drawbar out as far as the stop
- Press the drawbar up and down. With square, delta and tubular overrun devices, play must be not more than +/- 1.5 mm.

## Overrun and coupling attachment bolts

- Check all attachment bolts of the overrun device and coupling for tightness. (Ensure the correct tightening torque)

### Breakaway cable

- Check the ring of the breakaway cable on the handbrake lever
- Check the condition of the cable guide
- Check the condition of the snap hook
- Check the condition of the cable

### 2.2.2 Lubrication

#### Lubrication intervals

Grease or oil sliding and swivelling points of the overrun device every 10,000 – 15,000 km or 12 months.

#### Lubrication points

- 1 Grease the drawbar in the area of the bellows.
- 2 Grease the bearing bush through the grease nipples on the housing and the cartridge.
- 3 Grease the pivot bolt of the overrun lever and handbrake levers through the grease nipple.
- 4 Grease the joint of the Brake rod end fitting.
- 5 Oil the joints of the spring cylinder in the handbrake lever.

Lubricant type: Multi-purpose grease to DIN 51825 KTA 3K4

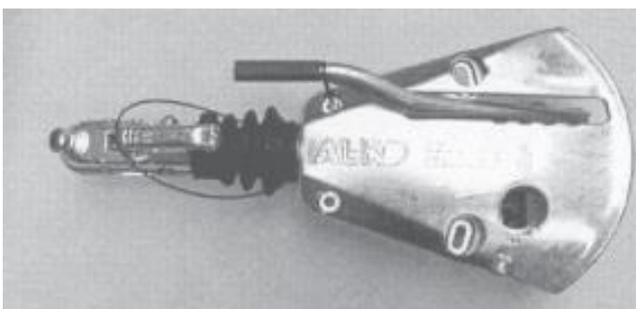
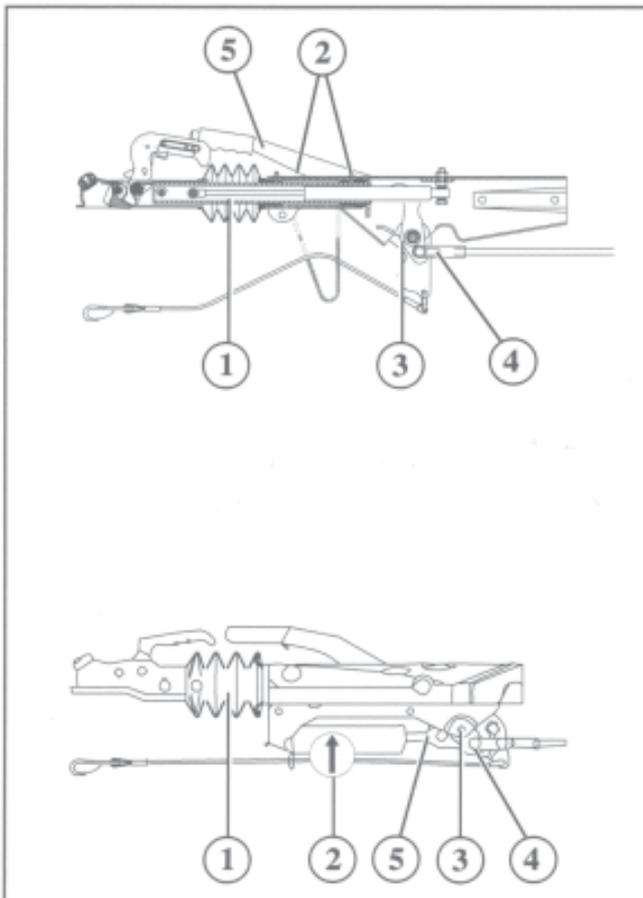

## 2.3 Repair

### 2.3.1 Removing the handbrake lever



Repairing the overrun device is made easier if the complete overrun device is unbolted and removed.

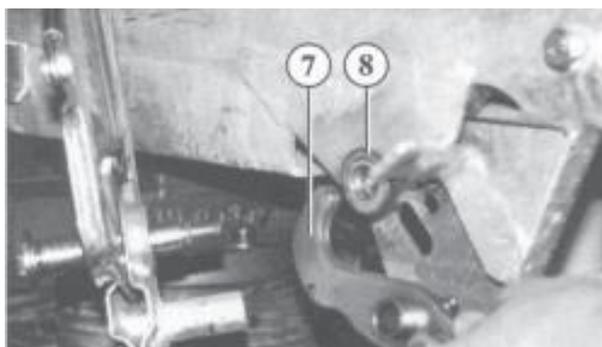
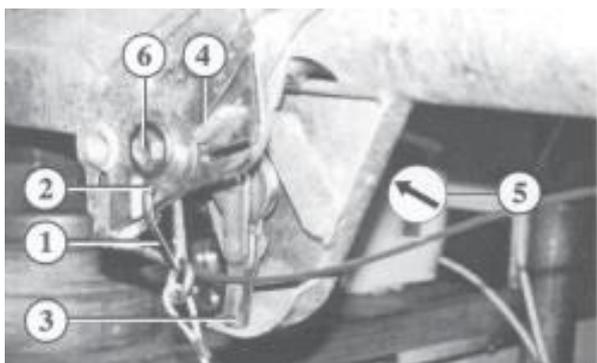

### Removing the handbrake lever on delta, square and tubular overrun devices



Caution: Injuries can be caused by the handbrake flying up

- Clip the snap hook (1) of the breakaway cable into hole (2).
- Unscrew the brake rod from the rod end fitting (3).
- Unclip the snap hook (1) of the breakaway cable.
- Position the handbrake cable (4) vertically.
- Unscrew the nut (5) from the pivot screw (6).
- Withdraw the handbrake lever (4) with pivot screw (6).



When withdrawing the handbrake lever, the overrun lever (7) and a shim washer (8) will drop out of the overrun device.

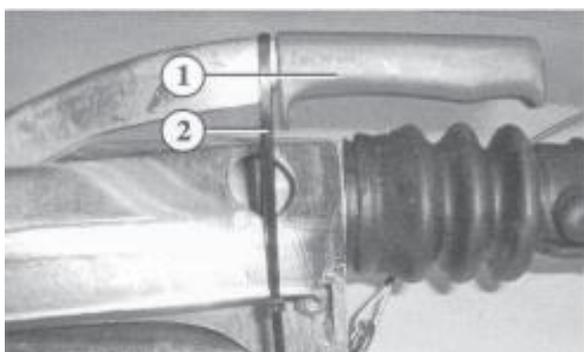

### Removing the handbrake lever on the Euro overrun device



Caution: Injuries can be caused by the handbrake lever flying up.

- Secure the handbrake lever (1) with a cable tie (2).
- Unscrew the brake rod (3) from the rod end fitting (4)

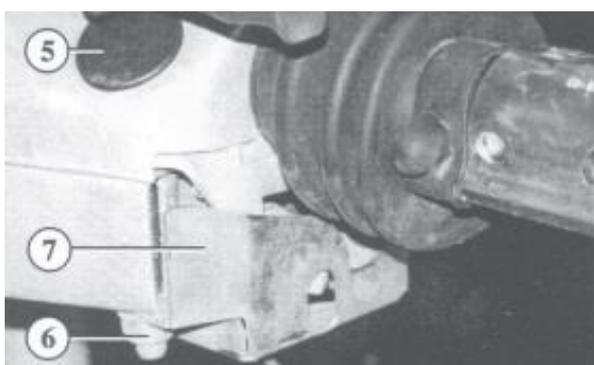
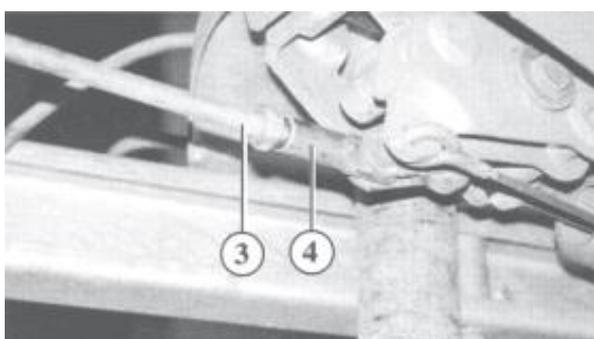

- Remove plug (5)
- Unscrew nuts (6) and take off the cover plate (7)

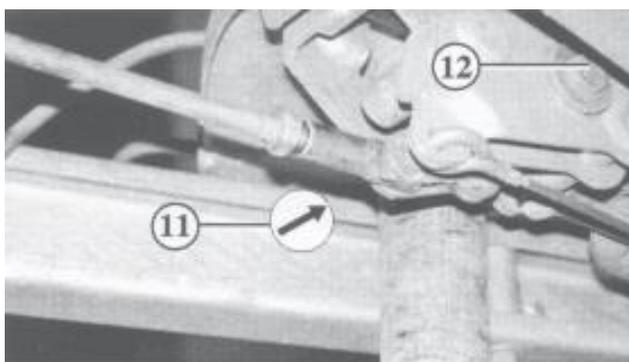
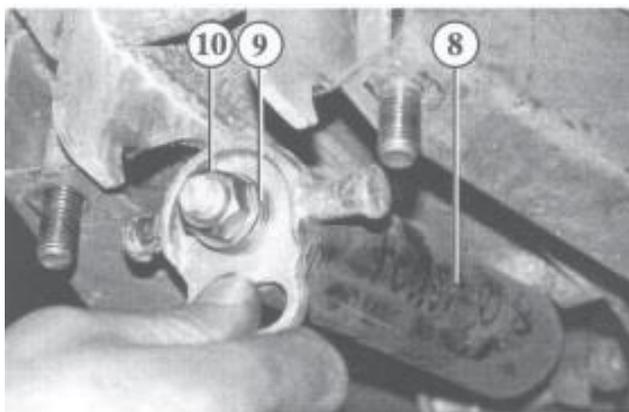

- Secure the spring cylinder (8) with 4 to 5 DIN 125 A13 washers (9) and a DIN 934 M12 nut (10)
- Remove the cable tie
- Position handbrake lever vertically and remove the spring cylinder (8) from underneath



When dismantling, the spring cylinder (8) will drop out

- Unscrew the nut (11) from the pivot screw (12).
- Take out the pivot screw (12).
- Position the handbrake lever vertically and withdraw downwards.



When withdrawing the handbrake lever, the overrun lever (7) and a shim washer (8) will drop out of the overrun device.

### 2.3.2 Installing the handbrake lever

#### Installing the handbrake lever on delta, square and tubular overrun devices



Caution: Injuries can be caused by the handbrake lever flying up

- Using grease, stick the shim washer to the opening of the hole in the housing
- Insert and hold the overrun lever (2) with the hook in the direction of travel
- Insert the handbrake lever (3) with pivot screw (4) pushed through

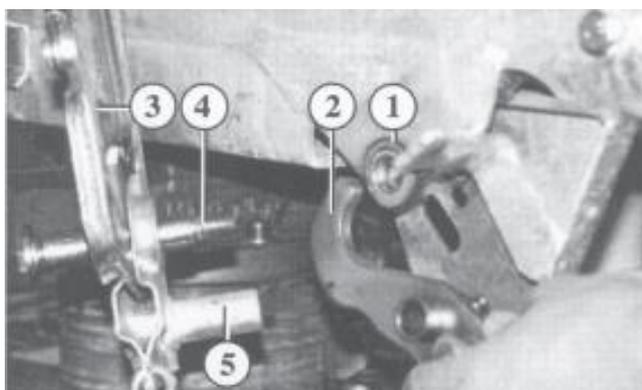

The overrun lever (2) must be in front of the carrier (5) of the hand brake lever (3) in the direction of travel



Fit the slotted hole (7) on the handbrake lever segment onto the tongue (6) on the housing (see page 5)

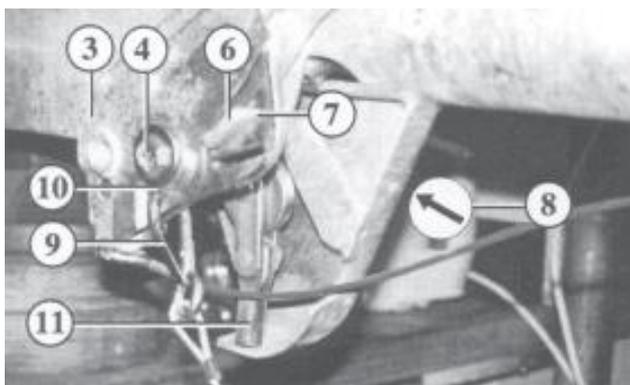

- Screw the nut (8) onto the pivot screw and tighten to 86 Nm
- Move the handbrake lever (3) downwards
- Clip the snap hook (9) of the breakaway cable into hole (10)
- Screw the brake rod into the rod end fitting (11) and tighten the locknut
- Unclip the snap hook of the breakaway cable.
- Adjust the braking system and check for correct operation



The shim washer (1) must not be tilted between the handbrake lever and the housing.

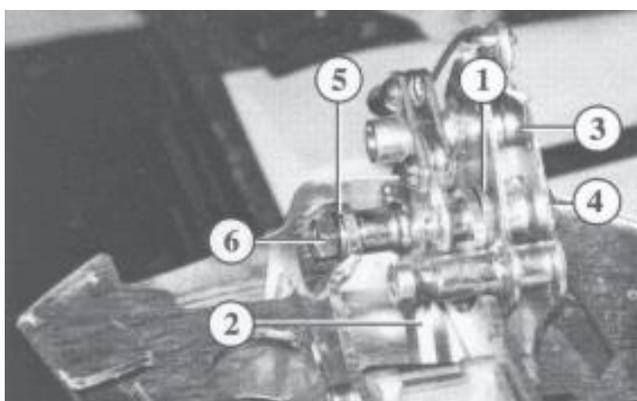

### Installing the handbrake lever on the Euro overrun device



Caution: Injuries can be caused by the handbrake lever flying up



Beware of trapped fingers when installing the spring cylinder.

- Using grease, stick the shim washer to the opening of the hole in the housing
- Insert and hold the overrun lever (2) with the hook in the direction of travel
- Insert the handbrake lever (3) from below.
- Insert the pivot screw (4) and put on the shim washer (5).
- Fit the nut (6) and tighten to 86 Nm.
- Position the handbrake lever vertically.

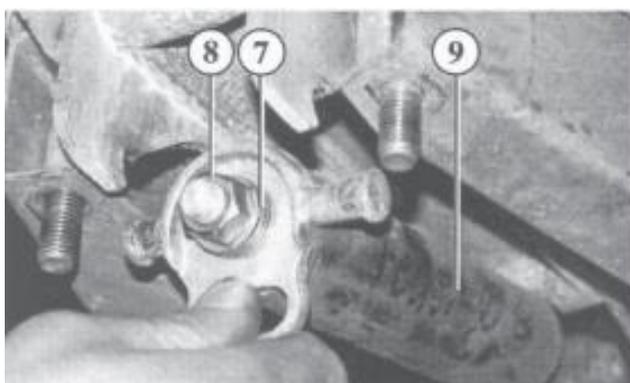

- Place the spring cylinder (9) secured with the washers (7) and nut (8) in its mounting and move the handbrake lever downwards.



Caution: Injuries can be caused by the handbrake lever flying up.

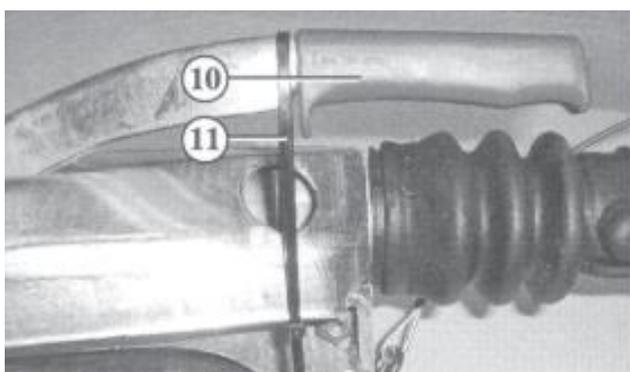

- Secure the handbrake lever (10) with a cable tie (11).
- Remove the nut and washers from the spring cylinder.

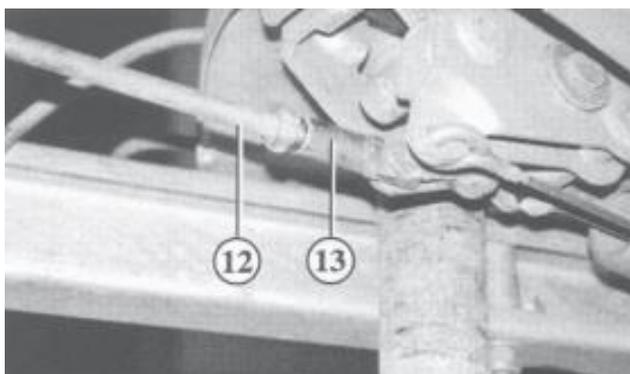

- Screw the brake rod (12) to the end fitting (13) and tighten the locknut

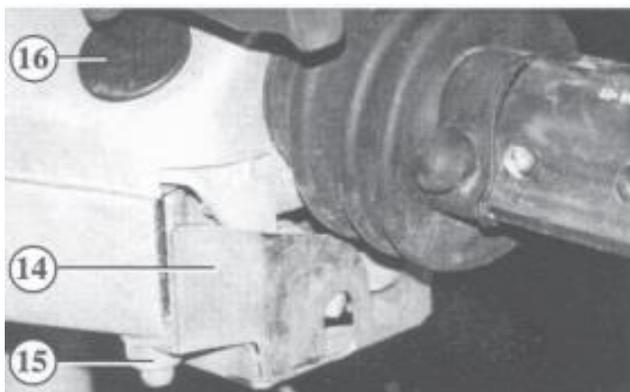

- Put on the cover plate (14).
- Fit new self-locking nuts (15) and tighten to 86 Nm
- Insert plug (16)
- Remove cable tie
- Adjust braking system and check for correct operation



Do not re-use self-locking nuts.

### 2.3.3 Removing the spring cylinder

#### Removing the spring cylinder unit with delta, square and tubular overrun devices

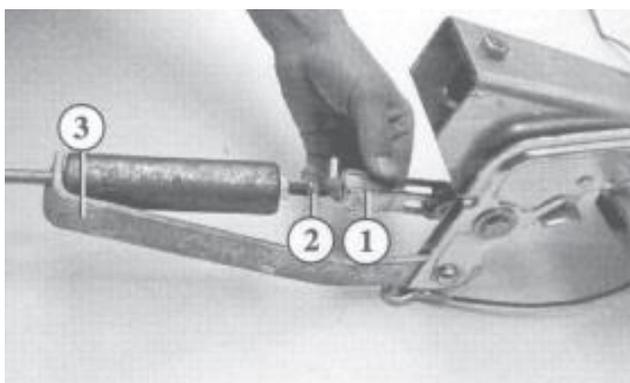

- Unscrew the brake rod from the clevis (1)
- Loosen the locknut (2)
- Take the rod out of the clevis (1) and out of the support bracket (3).

#### Removing the spring cylinder on the Euro overrun device

This work is described in the section “Removing the handbrake lever on the Euro overrun device”.

### 2.3.4 Installing the spring cylinder

#### Installing the spring cylinder on delta, square and tubular overrun devices

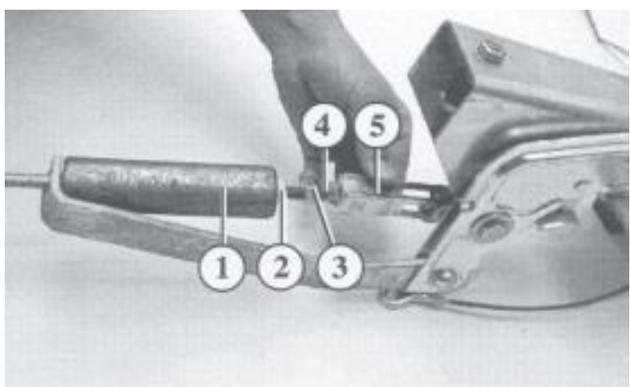

- Thread the cylinder (1) onto the rod
- Screw on the adjusting nut (2)
- Screw the locknut (3) onto the rod
- Screw the rod (4) into the clevis fitting (5)
- Screw the adjusting nut (2) up against the spring cylinder (1) so that there is no play
- Adjust the brake system and check for correct operation

### 2.3.5 Removing the overrun lever

#### Removing the overrun lever on delta, square, tubular and Euro overrun devices

This work is described in the section “Installing the handbrake lever on delta, square, tubular and Euro overrun devices”.

### 2.3.6 Replacing the overrun lever

#### Removing the overrun lever on delta, square, tubular and Euro overrun devices

This work is described in the section “Installing the handbrake lever on delta, square, tubular and Euro overrun devices”.

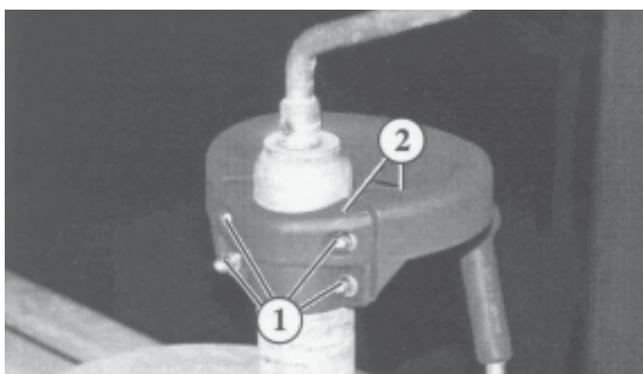

### 2.3.7 Removing the manoeuvring handle

- Unscrew and remove the screws (1)
- Remove the half shells from the jockey wheel tube

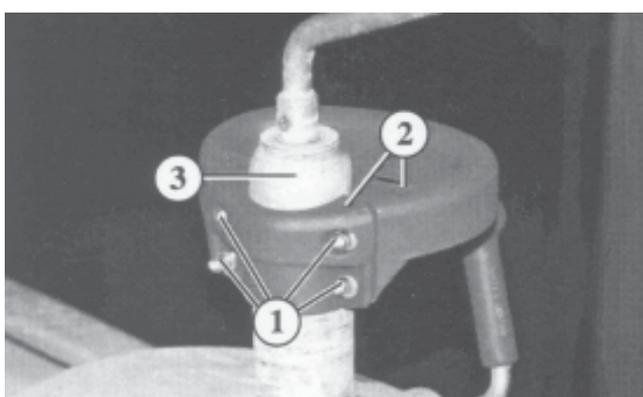

### 2.3.8 Installing the manoeuvring handle

- Press the two half shells together on the jockey wheel tube (3)
- Insert the four screws (1) and tighten in a diagonal sequence.

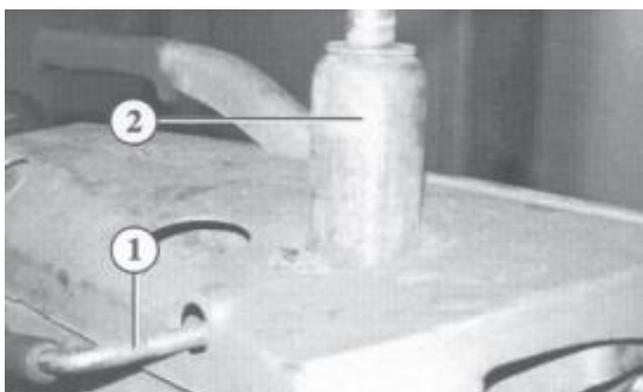

### 2.3.9 Removing the jockey wheel and clamp on the Euro-overrun device

- Loosen the locking lever (1)
- Take the jockey wheel (2) downwards out of the guide

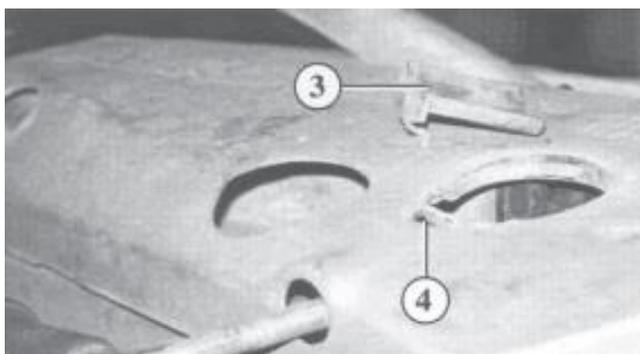

- Take the clamping shoe (3) out of the holder (4).

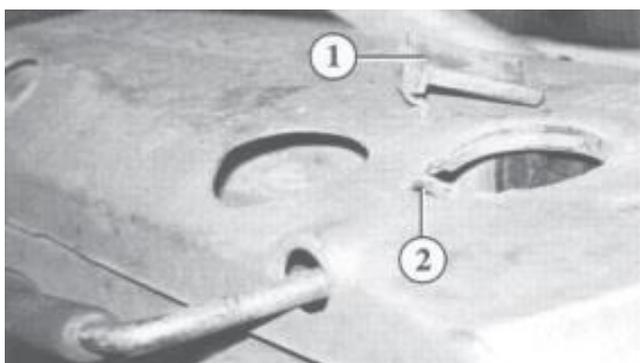

### 2.3.10 Installing the jockey wheel and clamp on the Euro-overrun device

- Insert the clamping shoe (1) into the holder (2)

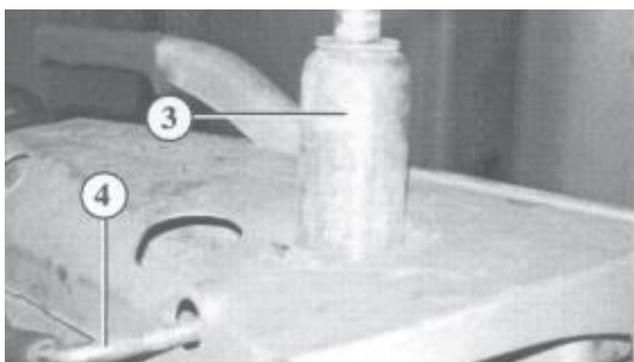

- Insert the jockey wheel (3) through the guide from underneath and pull up until the recess is reached
- Tighten the locking lever (4)

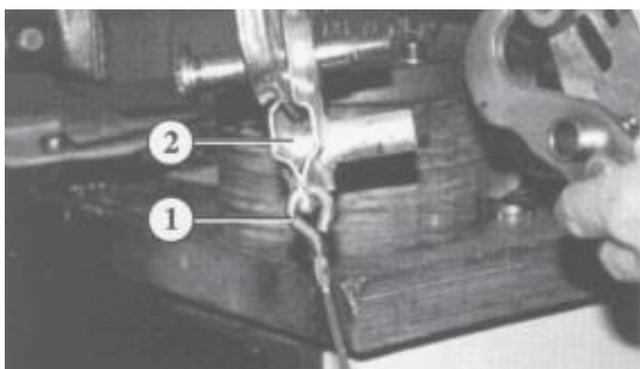

### 2.3.11 Removing the breakaway cable

- Using two pairs of pliers, open the breakaway eye (1) on the brake lever (2) and unhook it

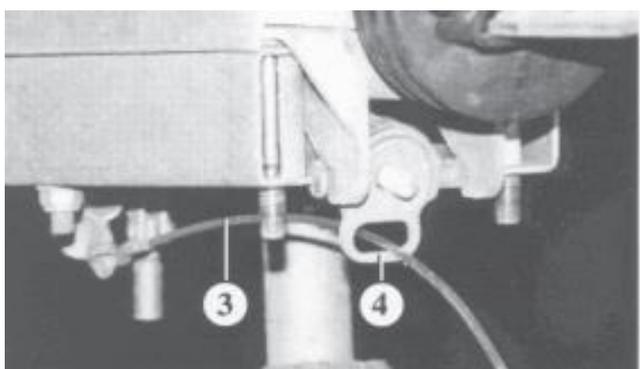

- Withdraw the breakaway cable (3) through the guide bracket (4)

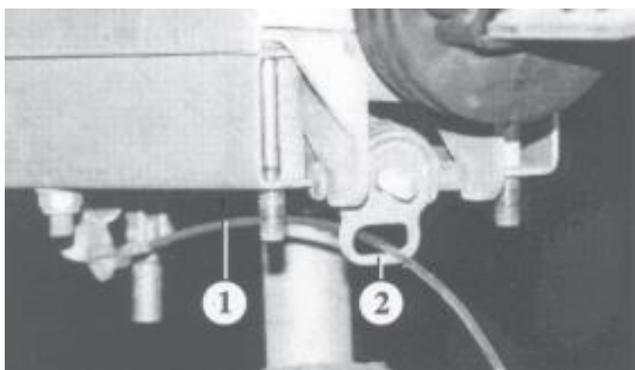

### 2.3.12 Installing the breakaway cable

- Pull the breakaway cable (1) through the guide bracket (2)
- Hook the breakaway cable (3) onto the brake lever (4) and press together with pliers

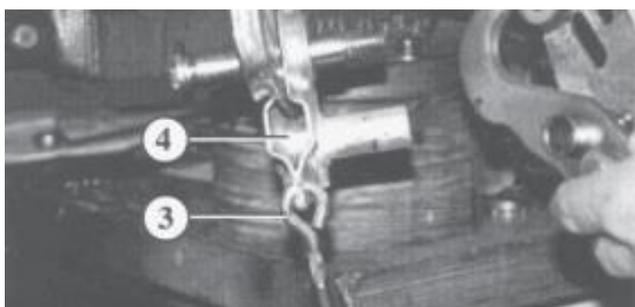

The breakaway eye (3) must be completely closed.



The breakaway ring used in older models can be replaced with the new breakaway eye.

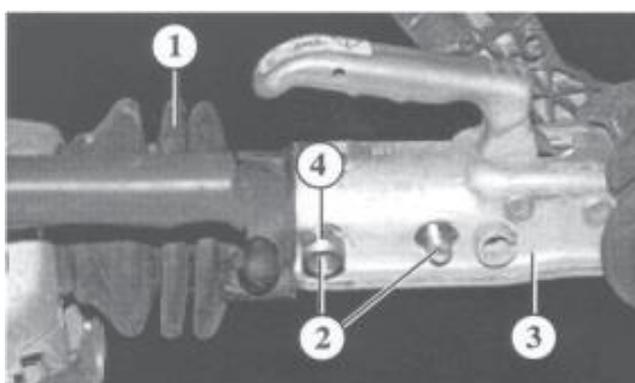

### 2.3.13 Removing the bellows

- Pull the bellows (1) off the rear attachment bolt (2) of the coupling (3)
- Unscrew the nuts (4) of the attachment bolts (2)

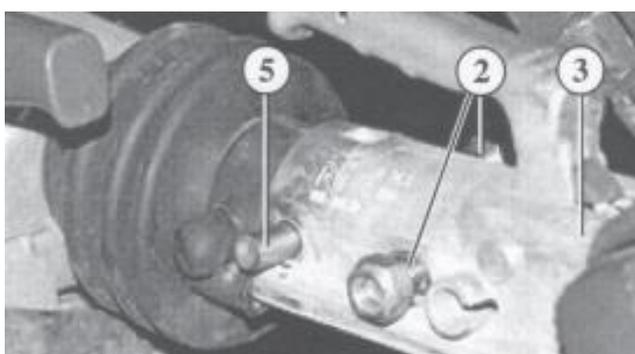

- Drive out the rear attachment bolt (2) with a 10 mm diameter retaining pin (5) (length to suit drawbar diameter)
- Leave the retaining pin pushed through the drawbar
- Drive out the front attachment bolt (2). (Remember the spacer tube)
- Take off the coupling (3)



The retaining bolt (5) keeps the eye of the damper in position. This is necessary because of the outward force exerted by the damper.

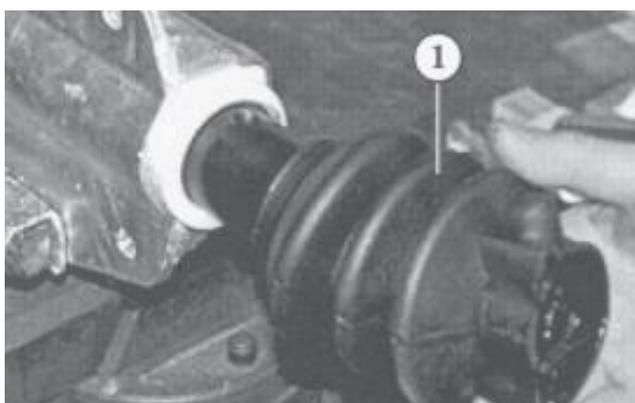

- Pull off the bellows (1)

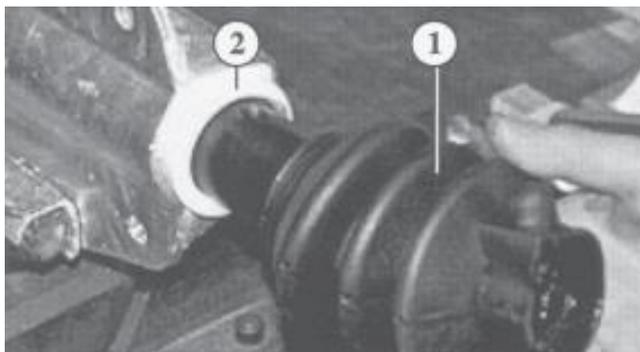

### 2.3.14 Installing the bellows

- Fit the bellows (1) onto the bearing bush (2)
- Insert the spacer tube into the drawbar in line with the front attachment bolt

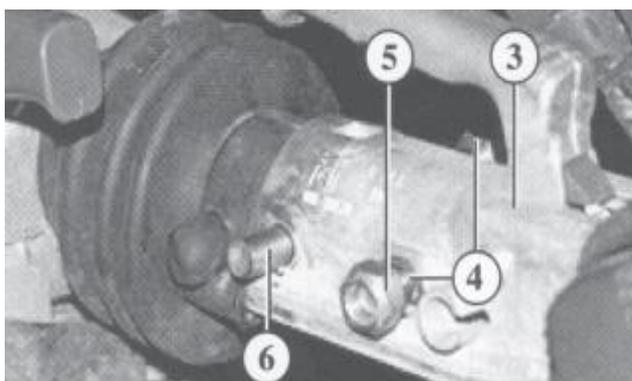

- Fit the coupling (3)
- Insert the attachment bolts (4)
- Fit new self-locking nuts (5) and tighten to 86 Nm



When inserting the rear attachment bolt, the damper eye retaining pin (6) is driven out.



Do not re-use self-locking nuts.

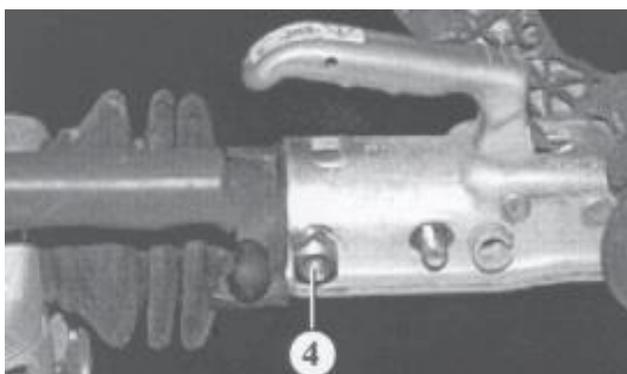

- Pull the bellows over the attachment bolt (4)

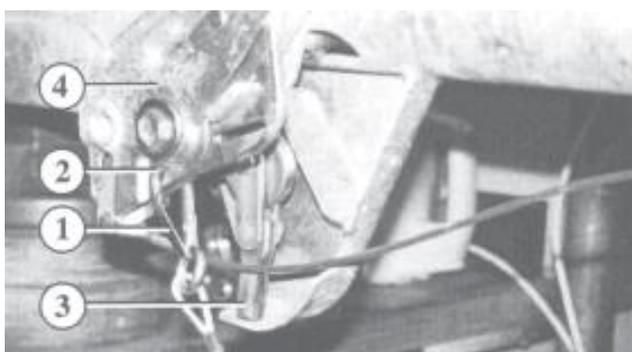

### 2.3.15 Removing the drawbar bearings

#### Removing the drawbar bearings on a tubular overrun device



Caution: Injuries can be caused by the handbrake flying up

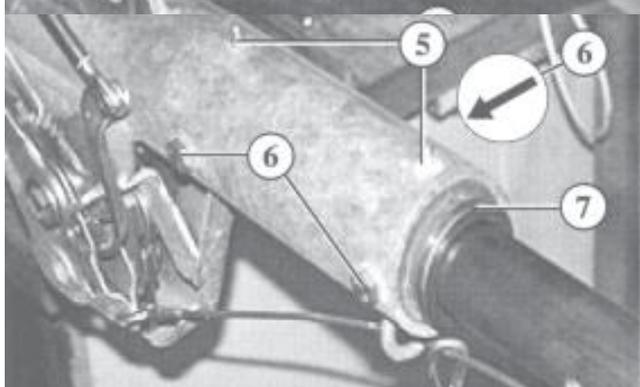

- Clip the snap hook (1) of the breakaway cable into hole (2)
- Unscrew the brake rod from the rod end fitting (3)
- Unclip the snap hook (1) of the breakaway cable
- Position the handbrake cable (4) vertically

- Unscrew grease nipple (5)
- Unscrew and remove the retaining screws (6) of the bearing cartridge (7)

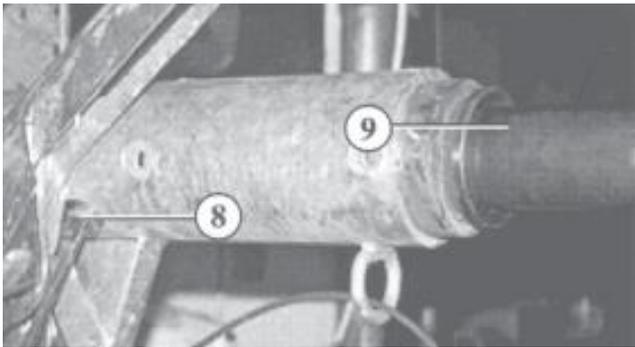

- Unscrew and remove the locating pin (8) of the drawbar (9)

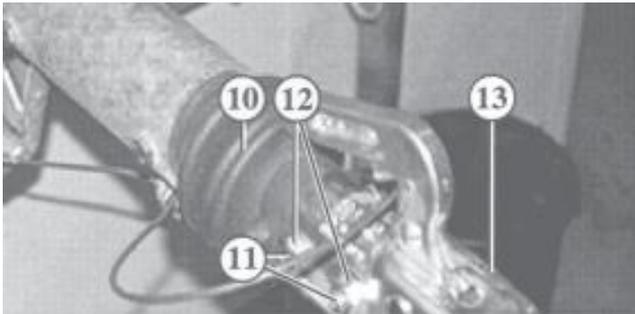

- Pull the bellows (10) off the rear attachment bolt (11)
- Unscrew the nuts (12) of the attachment bolts (11)
- Take out the attachment bolts (11)
- Take off the coupling (13)
- Pull off the bellows (10)

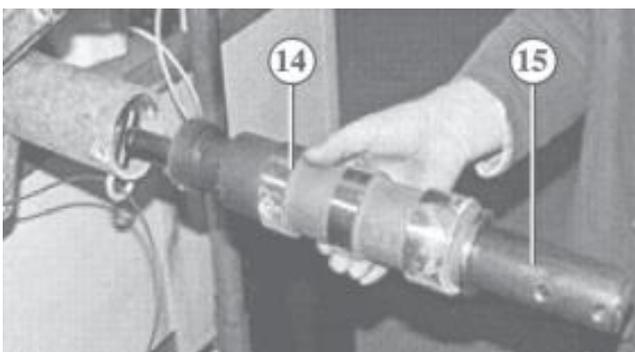

- Pull out the bearing cartridge (14) with the drawbar (15)
- Pull the drawbar backwards out of the bearing cartridge (14)

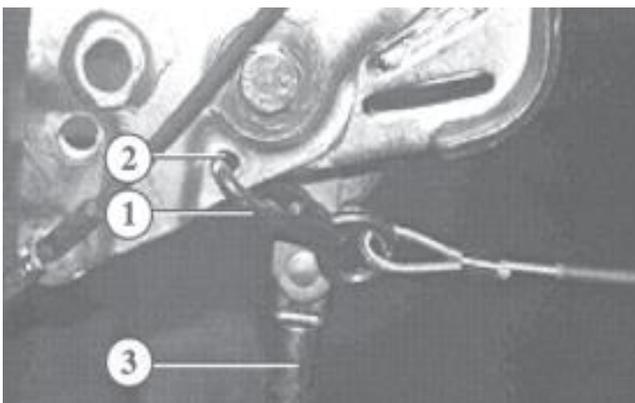

### Removing the drawbar bearings on delta, square and tubular overrun devices



Caution: Injuries can be caused by the handbrake flying up

- Clip the snap hook (1) of the breakaway cable into hole (2)
- Unscrew the brake rod from the rod end fitting (3)

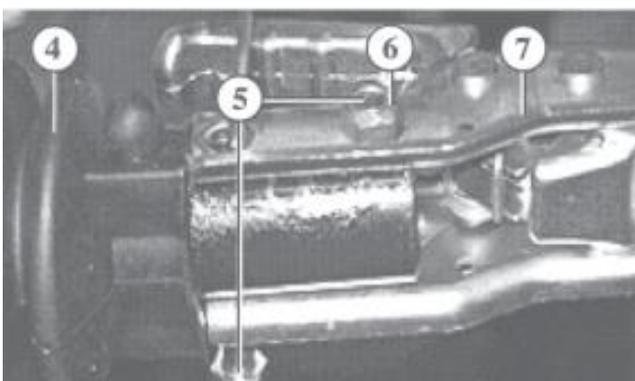

- Pull the bellows (4) off the rear attachment bolt (5)
- Unscrew the nuts (6) of the attachment bolts (5)
- Take out the attachment bolts (5)
- Take off the coupling (7)
- Pull off the bellows (4)

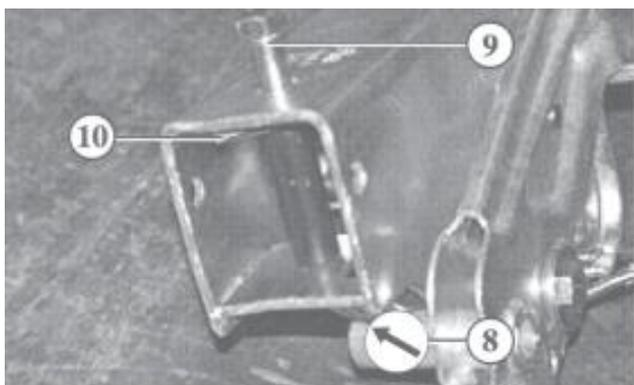

- Unscrew the nut (8) of the damper retaining bolt (9)
- Take out the damper retaining bolt (9)  
Take out the stop plate (10) of the drawbar

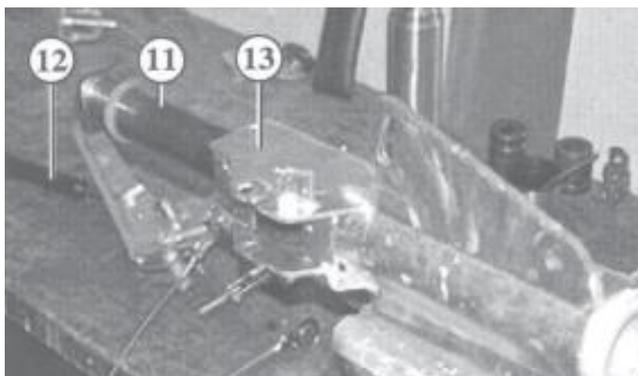

- Pull the drawbar (11) and damper (12) backwards out of the overrun device (13)

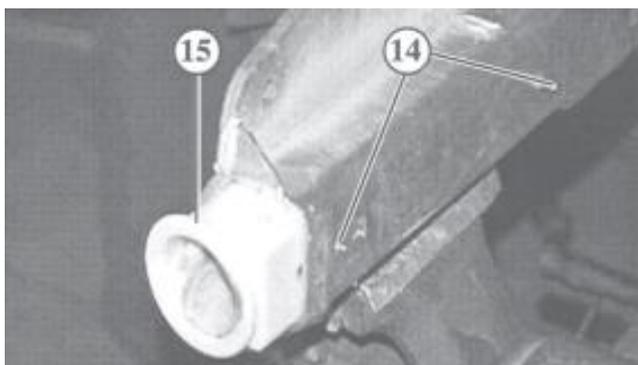

- Unscrew the grease nipples (14)
- Drive out the front and rear bearing bushes from the back and front respectively using a tube or extractor

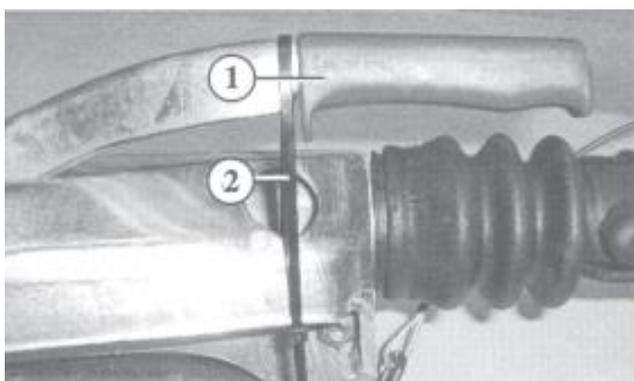

### Removing the drawbar bearings on the Euro overrun device



Caution: Injuries can be caused by the handbrake lever flying up.

- Secure the handbrake lever (1) with a cable tie (2).

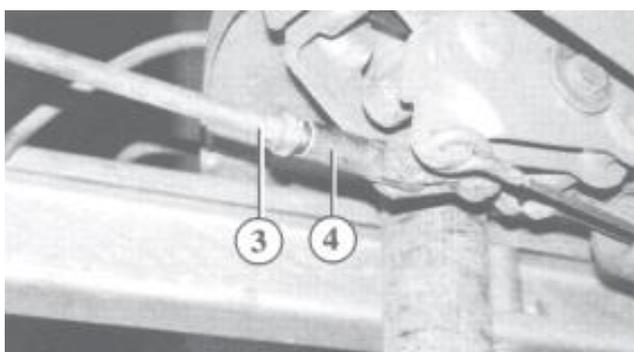

- Unscrew the brake rod (3) from the rod end fitting (4)

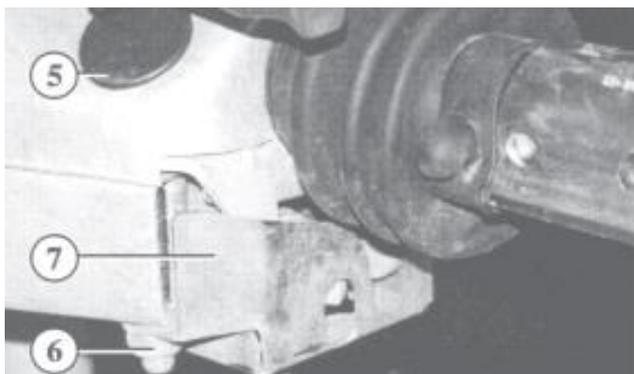

- Remove plug (5)
- Unscrew the nuts (6) and take off the cover plate (7).

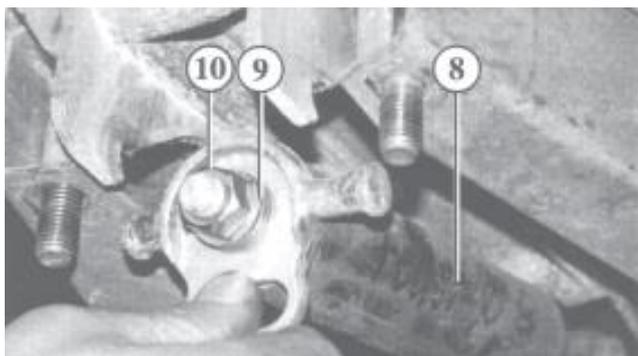

- Secure the spring cylinder (8) with 4 to 5 DIN 125 A13 washers (9) and a DIN 934 M12 nut (10).
- Remove the cable tie.
- Position the handbrake lever vertically and remove the spring cylinder (8) from underneath.



When dismantling, the cylinder (8) will drop out.

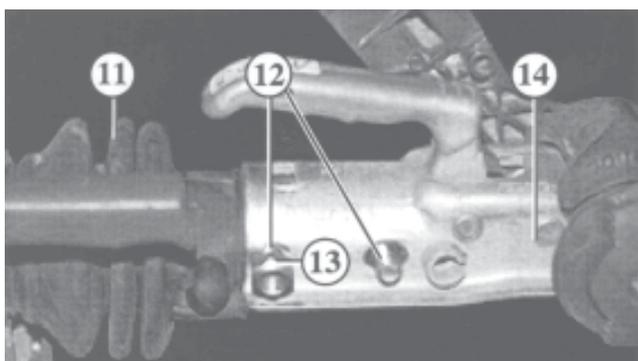

- Pull the bellows (11) off the rear attachment bolt (12)
- Unscrew the nuts (13) of the attachment bolts (12)
- Take out the attachment bolts (12)
- Take off the coupling (14)

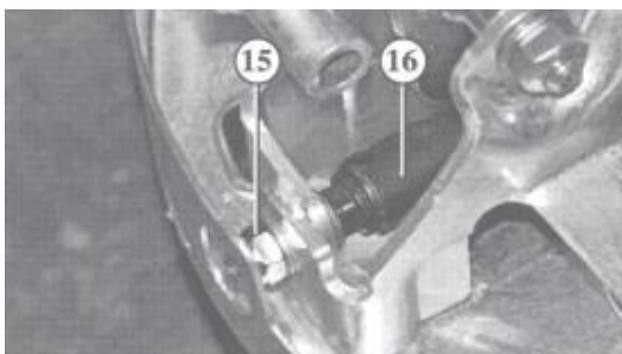

- Unscrew nut (15)
- Pull the damper (16) frontwards out of the drawbar

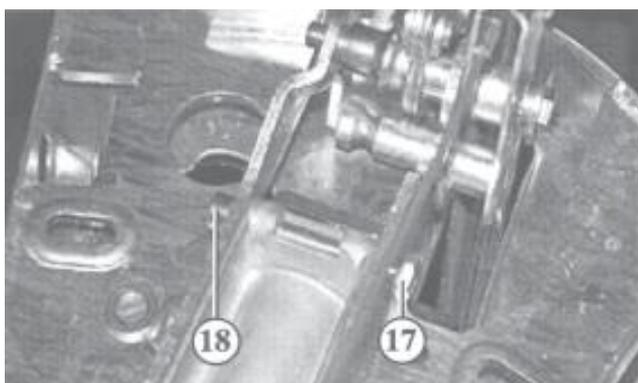

- Unscrew the nuts (17) of the attachment bolts (18)
- Take out the attachment bolts (18)

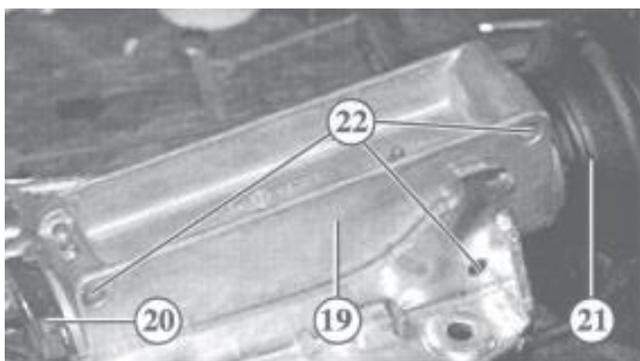

- Lift out the cast bearing cartridge (19) with the drawbar (20)
- Pull out the drawbar (20) and take off the bellows (21)



The holes (22) take the attachment screws for the cast bearing cartridge.



### 2.3.16 Installing the drawbar bearings

#### Installing the drawbar bearings on the tubular overrun device



Caution: Injuries can be caused by the handbrake lever flying up.

- Insert the drawbar (1) into the bearing cartridge (2)
- Slide the bearing cartridge (2) into the housing (3)

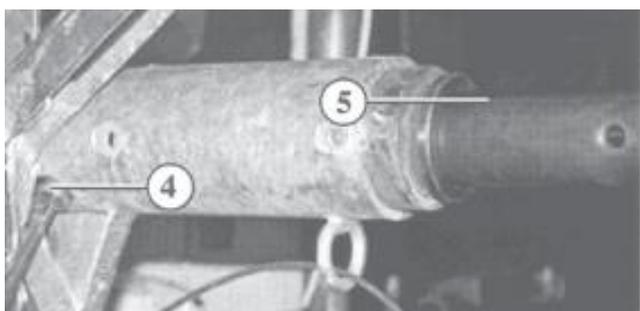

When inserting the bearing cartridge, make sure that the holes are correctly positioned.

- Screw the locating pin (4) into the drawbar (5)

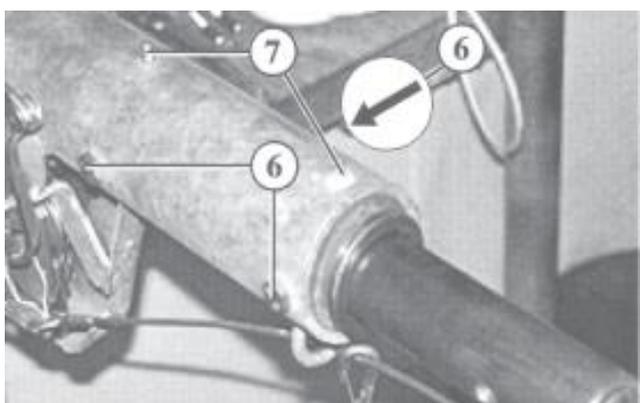

- Insert the retaining bolts (6) and tighten to 50 Nm
- Screw in grease nipples (7)
- Check that the drawbar moves freely
- Insert the spacer tube into the drawbar in line with the front attachment bolt

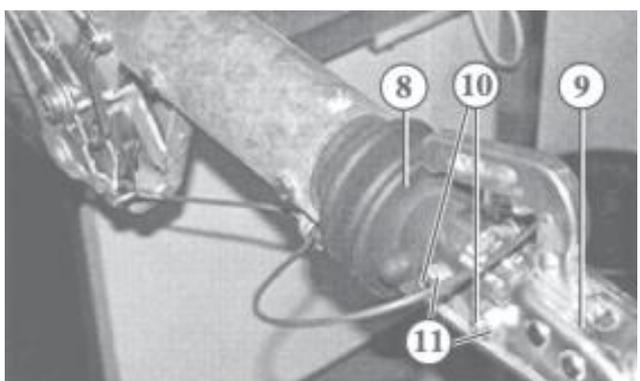

- Fit the bellows (8) onto the bearing cartridge
- Position the coupling (9)
- Insert the attachment bolt (10)
- Fit new self-locking nuts (11) and tighten to 86 Nm



The rear attachment bolt must pass through the front damper eye.



Do not re-use self locking nuts.

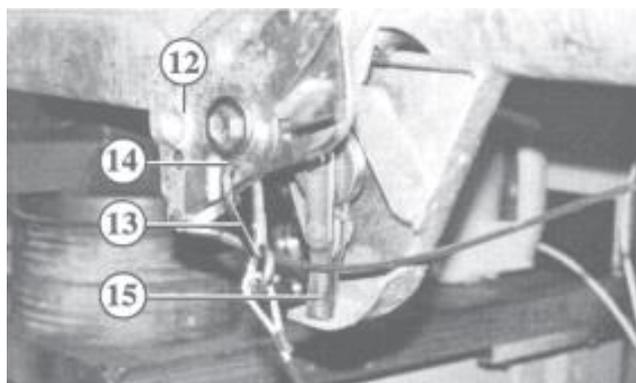

- Move the handbrake lever (12) downwards
- Clip the snap hook (13) of the breakaway cable into hole (14)
- Screw the brake rod into the rod end fitting (15) and tighten the locknut
- Adjust the braking system and check for correct operation

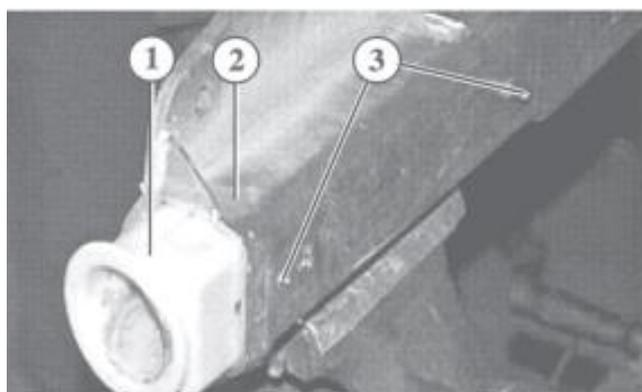

### Installing the drawbar bearings on delta and square overrun devices



Caution: Injuries can be caused by the handbrake flying up

- Press the front (1) and rear bearing bushes into the housing (2) as far as they will go, from the front and rear respectively
- Drill a 7 mm diameter hole for the grease nipples (3)
- Ream out the bearing bushes to the required fit using a reamer with guide
- Screw in the grease nipples (3)

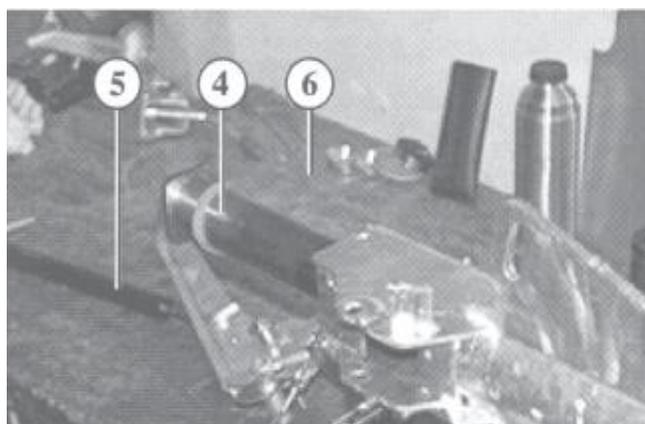

Different reamers are available (see tools list- Section 7).

- Insert the drawbar (4) and damper (5) into the overrun device (6) from the rear

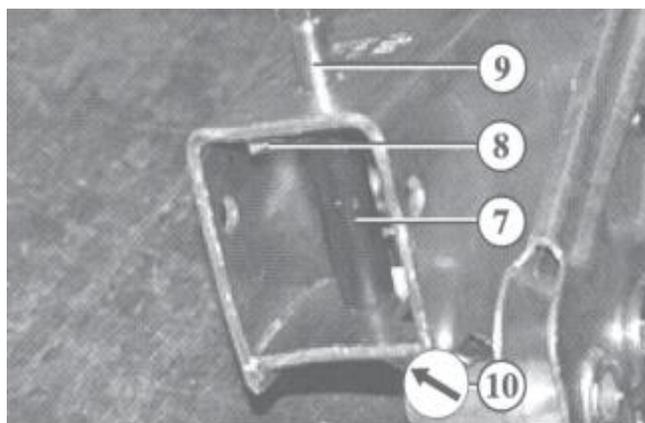

- Secure the damper (7) and stop plate (8)
- Insert the damper retaining bolt (9)
- Fit new self-locking nuts (10) and tighten to 50 Nm



Do not re-use self-locking nuts.

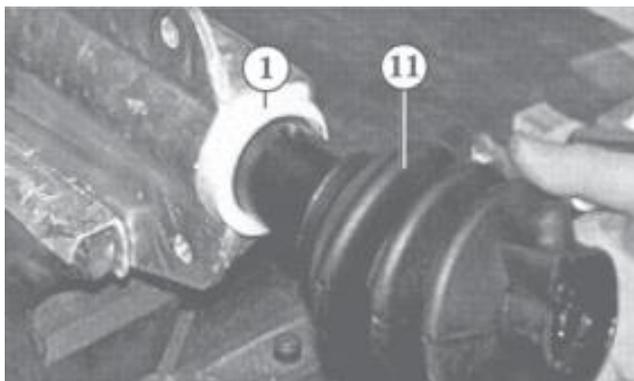

- Fit the bellows (11) onto the bearing bush (1)
- Insert the spacer tube into the drawbar in line with the front attachment bolt

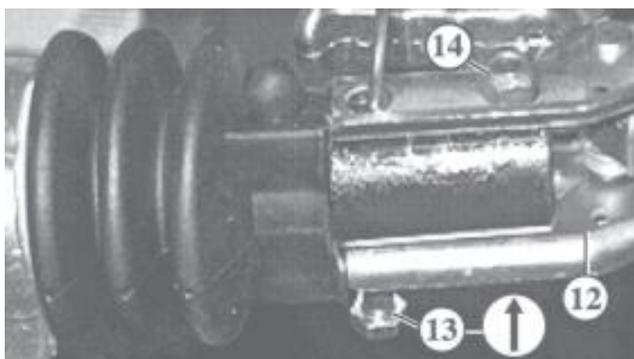

- Position the coupling (12)
- Insert the attachment bolts (13)
- Fit new self-locking nuts (14) and tighten to 86 Nm



The rear attachment bolt must pass through the front damper eye.



Do not re-use self locking nuts.

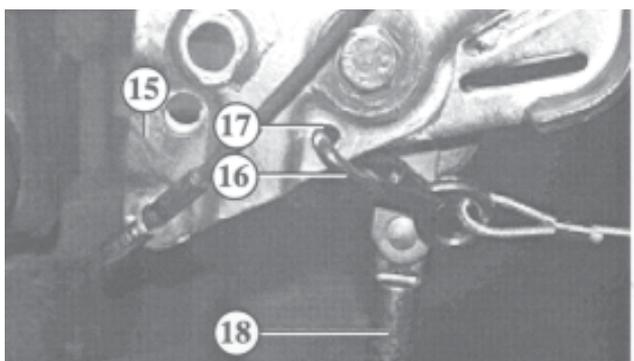

- Move the handbrake lever (15) downwards
- Clip the snap hook (16) of the breakaway cable into hole (17)
- Screw the brake rod into the rod end fitting (18) and tighten the locknut
- Adjust the braking system and check for correct operation

### Installing the drawbar bearings on the Euro overrun device

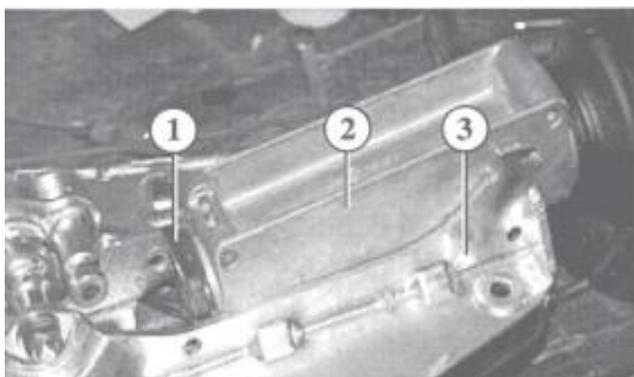

Caution: Injuries can be caused by the handbrake lever flying up



Beware of trapped fingers when installing the spring cylinder.

- Push the drawbar (1) into the bearing cartridge (2) from the rear
- Insert the bearing cartridge (2) into the overrun device

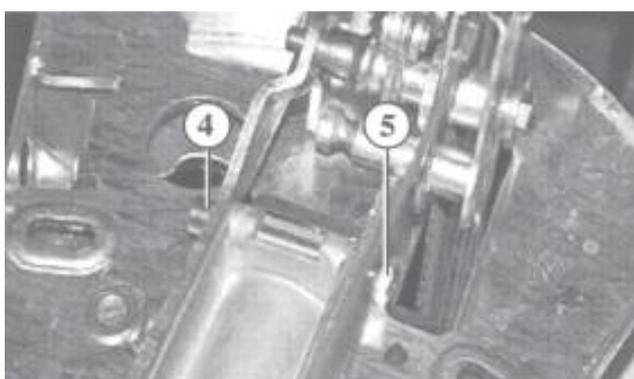

- Insert the attachment bolts (4)
- Fit new self-locking nuts (5) and tighten to 40 Nm +/- 5 Nm
- Check that the drawbar moves freely



Do not re-use self-locking nuts.

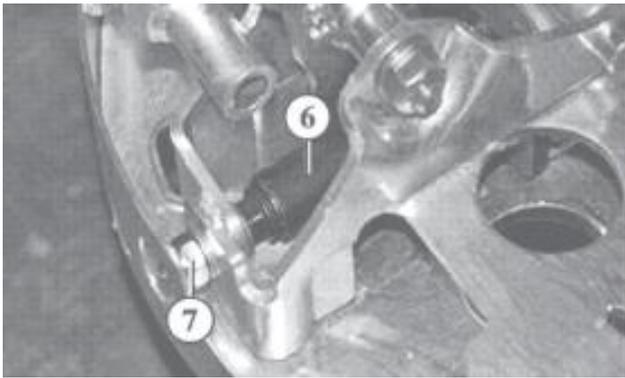

- Insert the damper (6) with damping rubber into the drawbar from the front
- Fit the nut (7) and tighten to 50 Nm

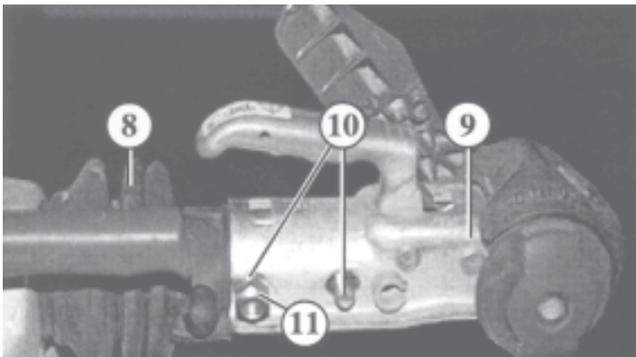

- Fit the bellows (8) onto the bearing cartridge
- Insert the spacer tube into the drawbar in line with the front attachment bolt
- Position the coupling (9)
- Insert the attachment bolts (10)
- Fit new self-locking nuts (11) and tighten to 86 Nm

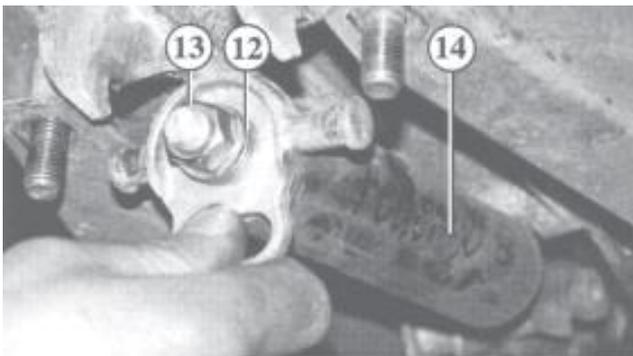

The rear attachment bolt must pass through the front damper eye.



Do not re-use self-locking nuts.

- Position the handbrake lever vertically
- Place the spring cylinder (14) secured with the washers (12) and nut (13) in its mounting and move the handbrake lever downwards

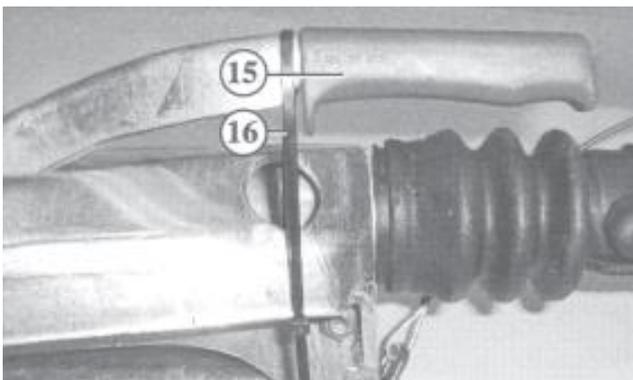

- Secure the handbrake lever (15) with a cable tie (16)
- Remove the nut and washers from the buffer unit

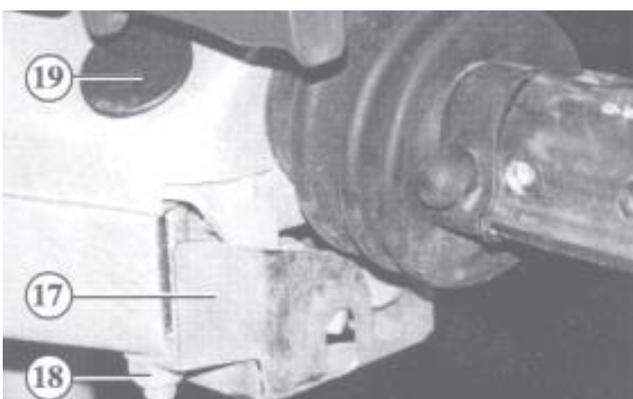

- Fit the cover plate (17)
- Fit new self-locking nuts (18) and tighten to 86 Nm
- Insert plug (19)



Do not re-use self-locking nuts.

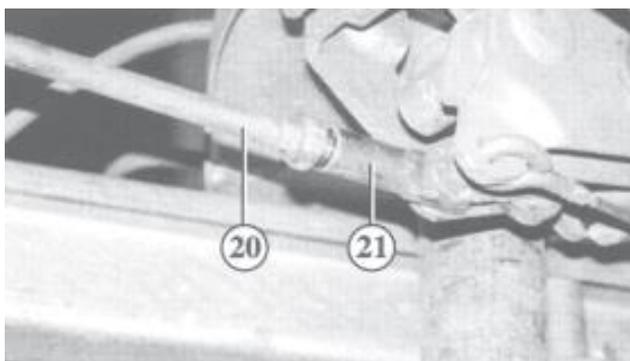

- Screw the brake rod (20) into the rod end fitting (21) and tighten the locknut
- Remove the cable tie
- Adjust braking system and check for correct operation

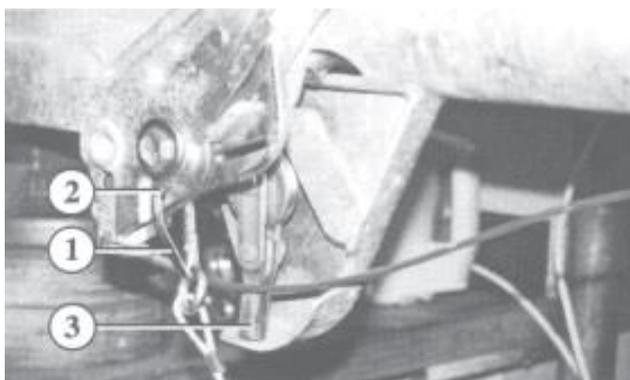

### 2.3.17 Removing the damper

#### Removing the damper on the tubular over run device



Caution: Injuries can be caused by the handbrake flying up

- Clip the snap hook (1) of the breakaway cable into hole (2).
- Unscrew the brake rod from the rod end fitting (3)

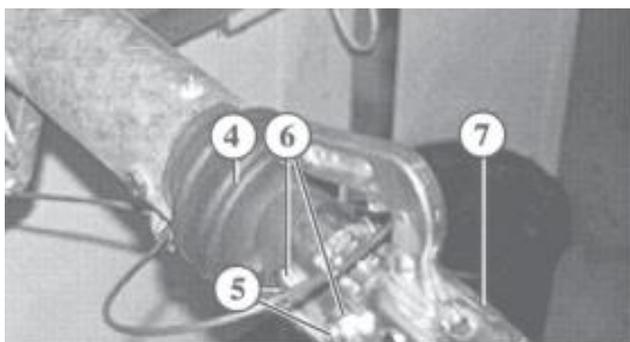

- Pull the bellows (4) off the rear attachment bolt (5)
- Unscrew the nuts (6) of the attachment bolts (5)
- Take out the attachment bolts (5)
- Take off the coupling (7)

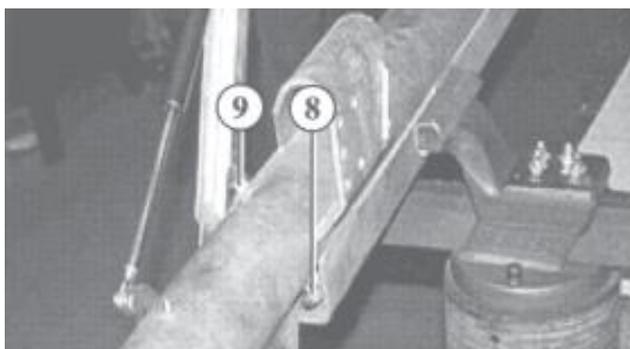

- Unscrew the nut (8) of the damper retaining bolt (9)
- Take out the damper retaining bolt (9)



Do not confuse the damper retaining bolt (9) with the handbrake lever pivot bolt.

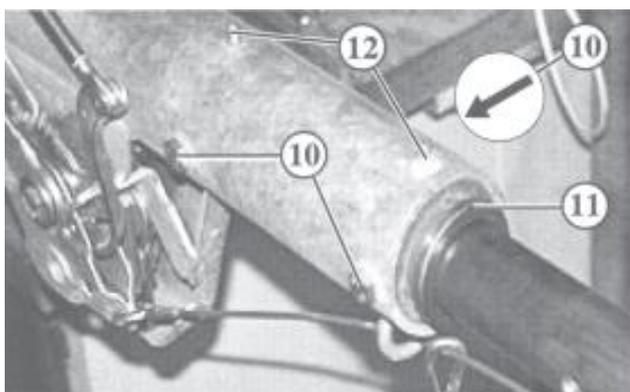

- Unscrew the retaining bolts (10) of the bearing cartridge (11)
- Unscrew the grease nipples (12)

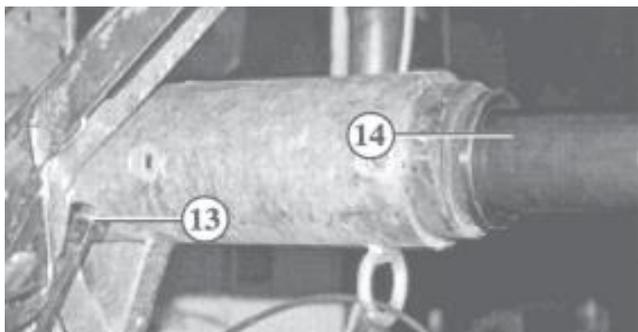

- Unscrew the locating pin (13) of the draw bar (14)

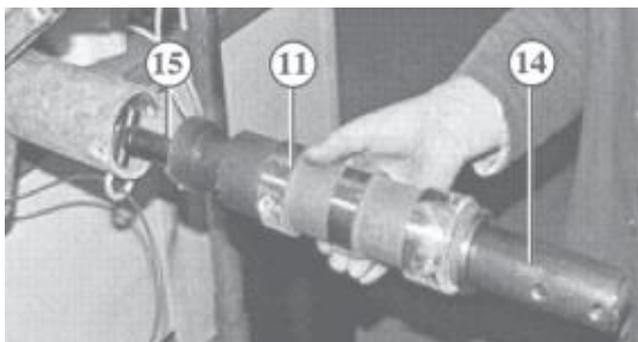

- Pull out the bearing cartridge (11) with the drawbar (14) and the damper (15)
- Take the damper (15) out of the drawbar (14) backwards

### Removing the damper on delta and square overrun devices



Caution: Injuries can be caused by the handbrake flying up



There are two different methods of securing the damper in the drawbar.

A: combined with the coupling bolts

B: separately with clamping sleeves

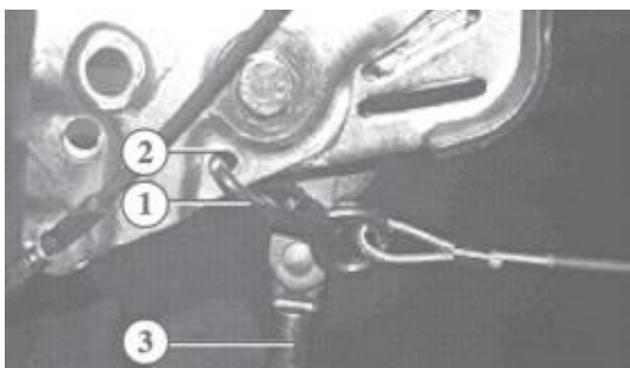

- Clip the snap hook (1) of the breakaway cable into hole (2)
- Unscrew the brake rod from the rod end fitting (3)

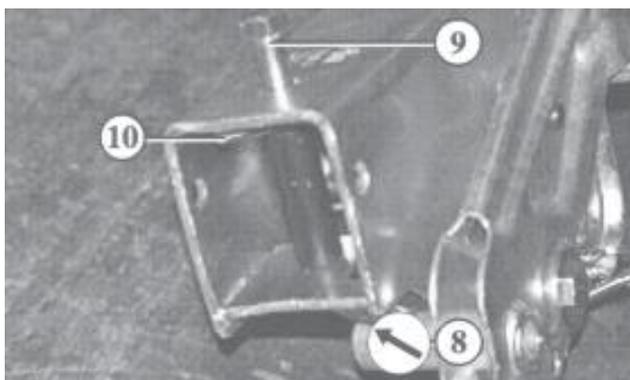

- Pull the bellows (4) off the rear attachment bolt (5)
- Unscrew the nuts (6) of the attachment bolts (5)
- Take out the attachment bolts (5)
- Take off the coupling (7)
- Pull off the bellows (4)
- Unscrew the nut (8) of the damper retaining bolt (9)
- Pull out the damper retaining bolt (9)
- Take out the stop plate (10) of the drawbar



- A:  
Pull the damper (11) backwards out of the overrun device (12)
- B:  
Move the drawbar with damper backwards and drive out the spring pins.

### Removing the damper on the Euro overrun device



Caution: Injuries can be caused by the handbrake lever flying up.

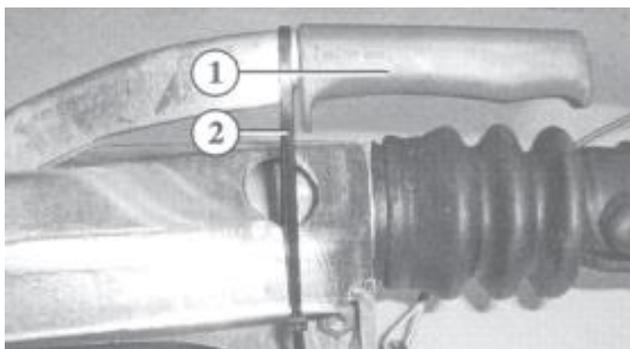

- Secure the handbrake lever (1) with a cable tie (2).

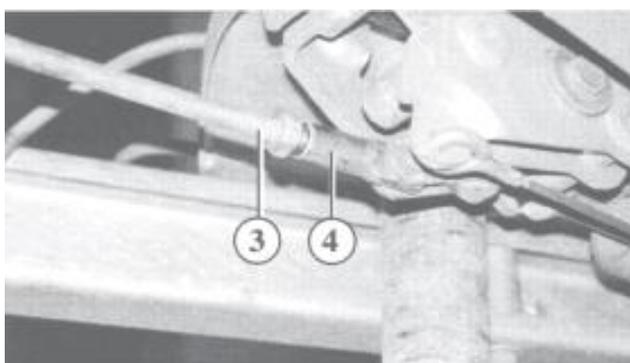

- Unscrew the brake rod (3) from the rod end fitting (4)

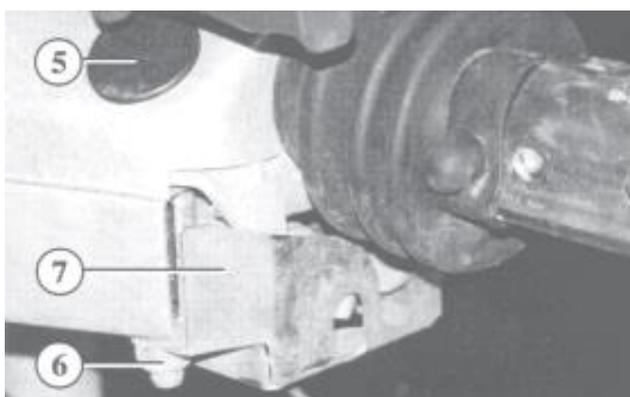

- Remove plug (5)
- Unscrew the nuts (6) and take off the cover plate (7).

- Secure the spring cylinder (8) with 4 to 5 DIN 125 A13 washers (9) and a DIN 934 M12 nut (10).
- Remove the cable tie.
- Position handbrake lever vertically and remove the spring cylinder (8) from underneath.



When dismantling, the cylinder (8) will drop out.

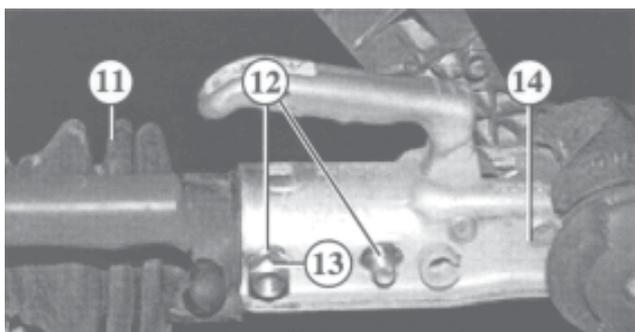

- Pull the bellows (11) off the rear attachment bolt (12)
- Unscrew the nuts (13) of the attachment bolts (12)
- Take out the attachment bolts (12)
- Take off the coupling (14)

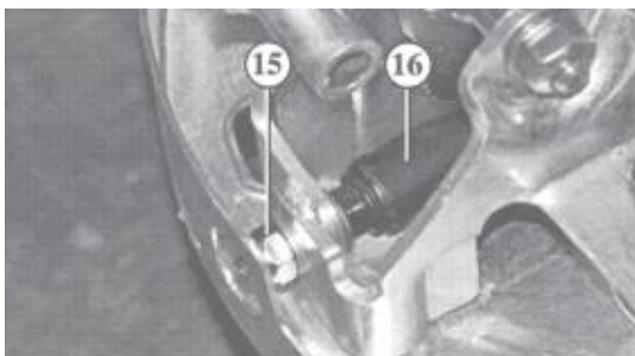

- Unscrew the nut (15)
- Pull the damper (16) frontwards out of the drawbar

### 2.3.18 Installing the damper

#### Installing the damper on the tubular overrun device

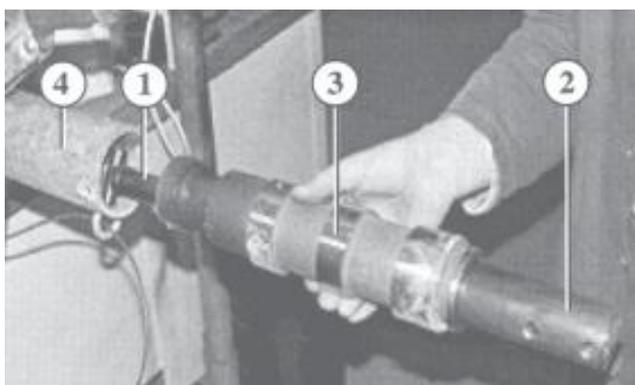

Caution: Injuries can be caused by the handbrake lever flying up.

- Insert the damper (1) and drawbar (2) into the bearing cartridge (3)
- Push the bearing cartridge (3) into the housing (4)

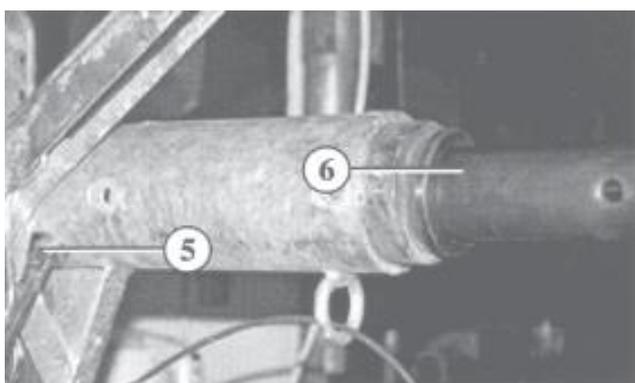

When inserting the bearing cartridge, make sure that the holes are correctly positioned.

- Screw the locating pin (5) into the drawbar (6)

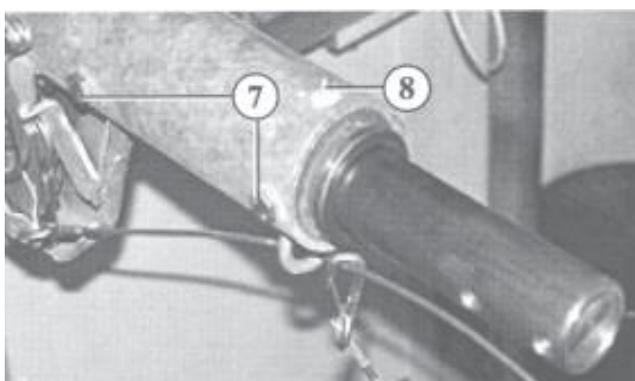

- Insert the retaining bolts (7) and tighten to 50 Nm
- Screw in the grease nipples (8)
- Check that the drawbar moves freely

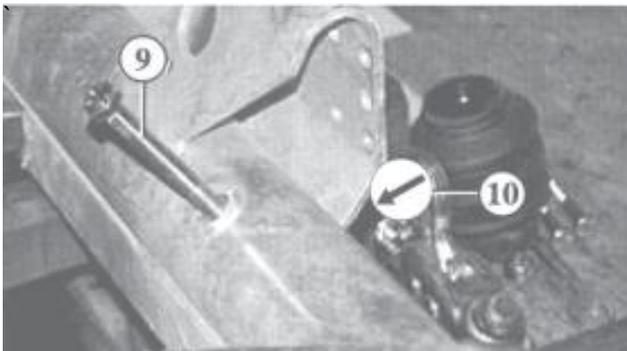

- Insert the damper retaining screw (9)
- Fit the nut and tighten to 86 Nm



The bolt (9) must pass through the rear damper eye.

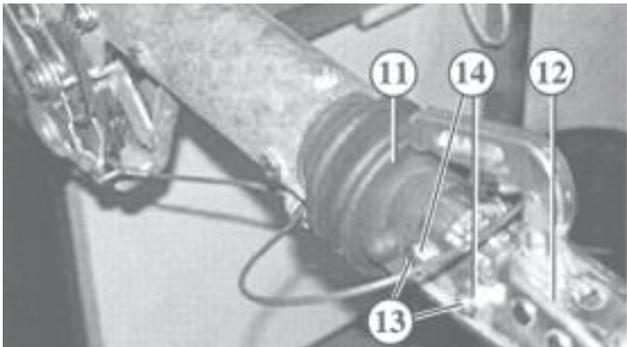

- Fit the bellows (11) onto the bearing cartridge
- Insert the spacer tube into the drawbar in line with the front attachment bolt
- Position the coupling (12)
- Insert the attachment bolts (13)
- Fit new self-locking nuts (14) and tighten to 86 Nm



The rear attachment bolt must pass through the front damper eye.



Do not re-use self locking nuts.

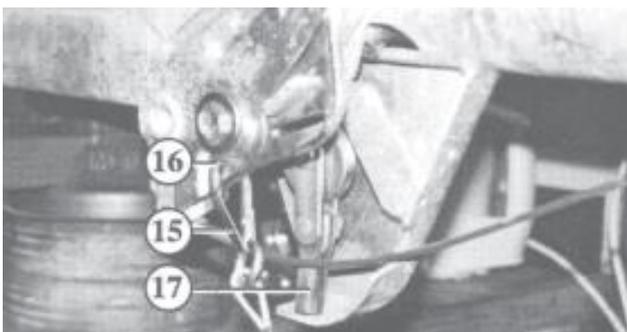

- Clip the snap hook (15) of the breakaway cable into hole (16)
- Screw the brake rod into the rod end fitting (17) and tighten the locknut
- Unclip the snap hook (15) of the breakaway cable
- Adjust the braking system and check for correct operation

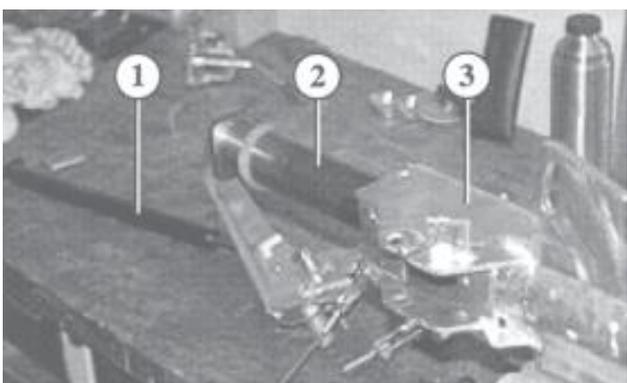

### Installing the damper on delta and square overrun devices



Caution: Injuries can be caused by the handbrake lever flying up.

- Insert the damper (1) and drawbar (2) into the housing from the rear

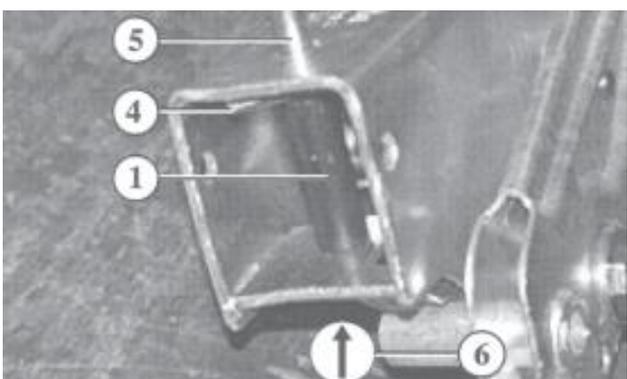

- Line up the damper (1) and stop plate (4)
- Insert the damper retaining bolt (5)
- Fit a new self-locking nut (6) and tighten to 86 Nm



Do not re-use self-locking nuts.

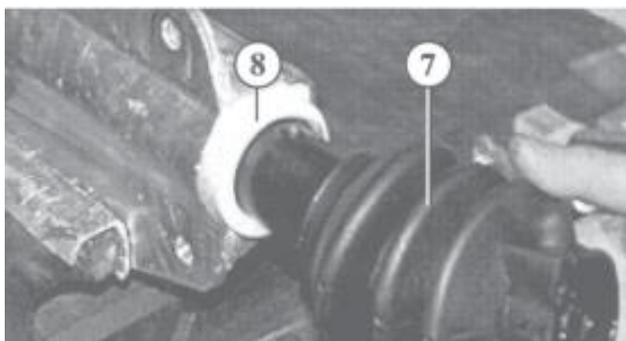

- Fit the bellows (7) onto the bearing bush
- Insert the spacer tube into the drawbar in line with the front attachment bolt

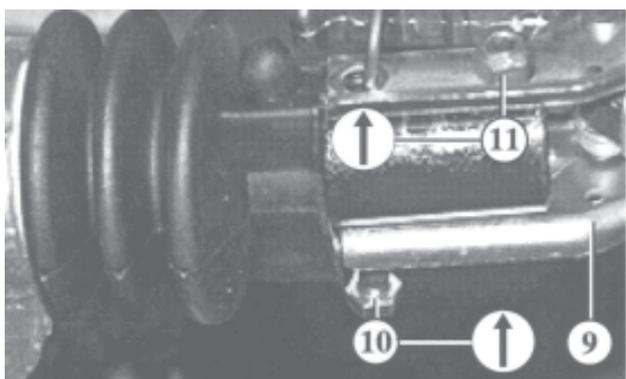

- Fit the coupling (9)
- Insert the attachment bolt (10)
- Fit new self-locking nuts (11) and tighten to 86 Nm



The rear attachment screw must pass through the front damper eye.



Do not re-use self-locking nuts.

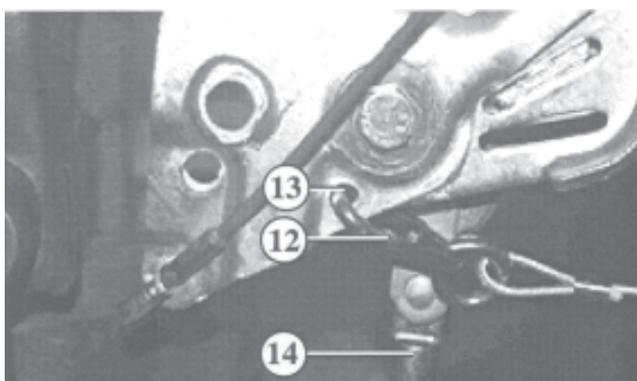

- Clip the snap hook (12) of the breakaway cable into hole (13)
- Unscrew the brake rod from the rod end fitting (14)
- Unclip the snap hook (12) of the breakaway cable
- Adjust the braking system and check for correct operation

### Installing the damper on the Euro over run device



Caution: Injuries can be caused by the handbrake lever flying up



Beware of trapped fingers when installing the spring cylinder.

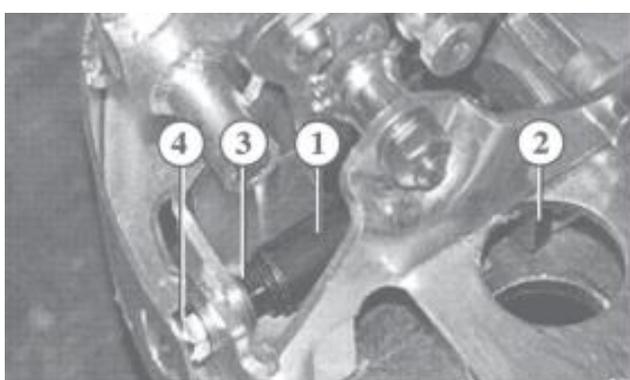

- Insert the damper (1) with damping rubber into the drawbar (2) from the front
- Insert the damper screw (3) through the hole in the housing
- Fit the nut (4) and tighten to 50 Nm

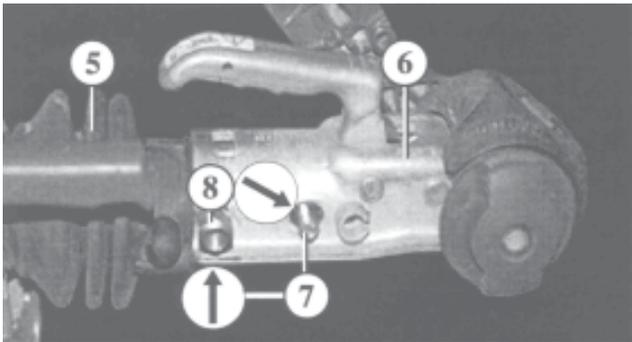

- Fit the bellows (5) onto the bearing cartridge
- Insert the spacer tube into the drawbar in line with the front attachment bolts
- Position the coupling (6)
- Insert the attachment bolts (7)
- Fit new self-locking nuts (8) and tighten to 86 Nm



The rear attachment bolts must pass through the front damper eye.



Do not re-use self locking nuts.

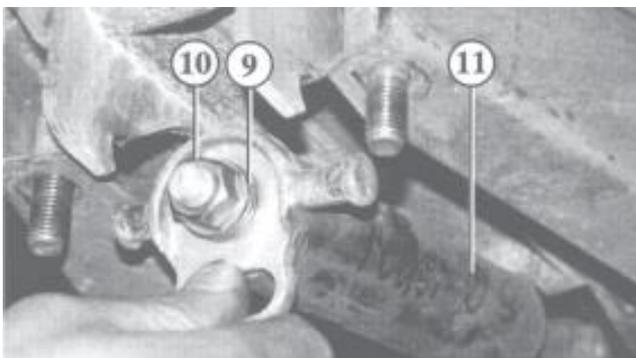

- Position the handbrake lever vertically.
- Place the spring cylinder (11) secured with the washers (9) and nut (10) in its mounting and move the handbrake lever downwards.

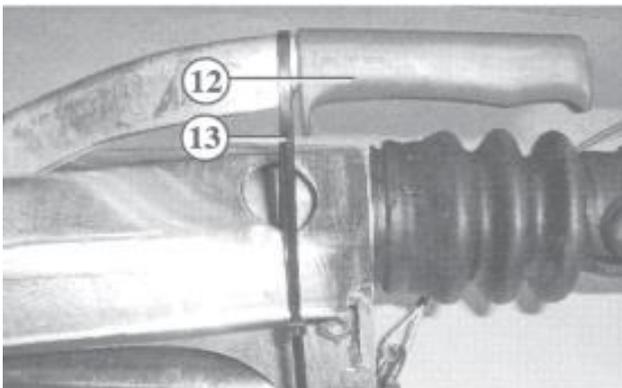

- Secure the handbrake lever (12) with a cable tie (13)
- Remove the nut and washers from the spring cylinder.

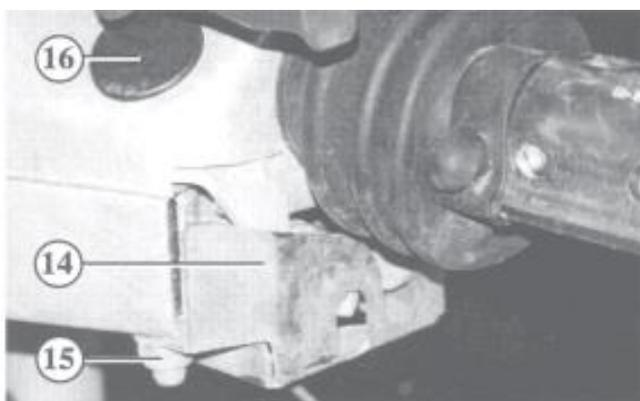

- Fit the cover plate (14)
- Fit new self-locking nuts (15) and tighten to 86 Nm
- Insert plug (16)



Do not re-use self-locking nuts.

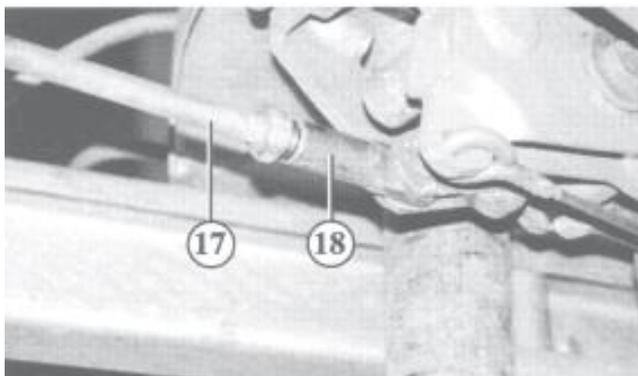

- Screw the brake rod (17) to the rod end fitting (18) and tighten the locknut.
- Remove the cable tie

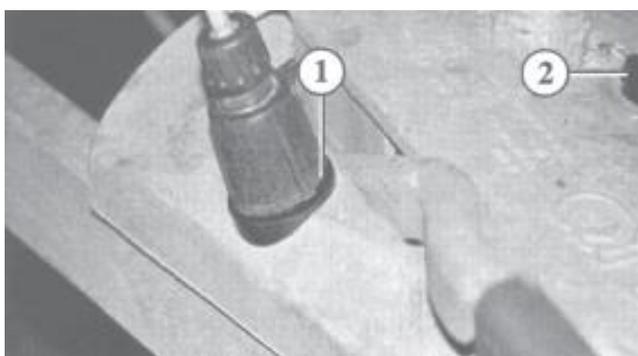

### 2.3.19 Removing the connector holder on the Euro overrun device

- Pull the connector holder for the 7 way (1) and 13 way (2) connectors out of the housing.

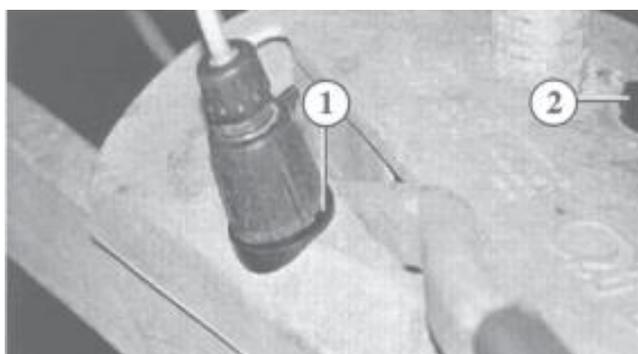

### 2.3.20 Installing the connector holder on the Euro overrun device

- Plug the connector holder for the 7 way (1) and 13 way (2) connectors into the housing