

INSTALLATION INSTRUCTIONS



Heavy Duty Suspension Kits for Double Eye Springs

K71-358-00 for Single Axles

K71-359-00 for Tandem Axles w/33" Axle Spacing

K71-360-00 for Triple Axles w/33" Axle Spacing

K71-448-00 for Tandem Axles w/4" High Equalizer

K71-449-00 for Tandem Axles w/35" Axle Spacing

K71-453-00 for Triple Axles w/35" Axle Spacing

K71-652-00 E-Z Flex® Complete Kit for Tandem Axles w/33" Axle Spacing, 6000# Max Capacity

K71-653-00 E-Z Flex® Complete Kit for Tandem Axles w/35" Axle Spacing, 8000# Max Capacity

K71-654-00 E-Z Flex® Equalizer & Bolts for Tandem Axles w/33" Axle Spacing, 6000# Max Capacity

K71-655-00 E-Z Flex® Equalizer & Bolts for Tandem Axles w/35" Axle Spacing, 8000# Max Capacity

Safety Precautions:

Before performing any maintenance or repair work requiring the raising of the vehicle, make sure that the vehicle is properly supported on lift stands of sufficient capacity. Follow the vehicle manufacturer's recommendations for lifting and supporting the unit. Do not lift with or place supports under any part of the suspension system unless specifically directed to do so during the disassembly and reassembly steps of these instructions.

CAUTION

Never rely on jacks alone to support the vehicle. A vehicle that is not securely supported may fall and cause severe injuries or death.

CAUTION

Safety glasses should be worn at all times when assembling or disassembling axles and their components. Failure to comply may result in serious eye injury.

Disassembly:

CAUTION

Axles and suspension components are heavy and must be carefully handled to avoid pinching, straining or crushing injuries to the body.

1. When the vehicle is raised and supported with the tires just clear of the ground, remove the wheel/tire assemblies from their respective hubs.
2. Disconnect any electrical wires or hydraulic brake lines from the axles.

3. Place small jacks under the equalizers. Gently lift the weight of the assembly until the bolts can be easily removed from the center frame hangers. Lower the partially disconnected assembly until the equalizers are clear of their respective hangers.
4. Carefully remove the spring ends from their respective hangers by supporting their weight and removing the bolts.
5. Remove the shackle link assemblies that attach the leaf spring ends to the equalizers.
6. Slide the axles out from underneath the vehicle.

Inspection:

1. Examine the bolt holes in the frame hangers. Holes that have been elongated or worn larger will not provide for a proper fit of the new bolts. The splined section of the bolt, adjacent to the bolt head is designed to create an interference fit in the hanger and prevent bolt rotation.

CAUTION

Loose fitting bolts can result in premature wear and lead to eventual failure. Failure of suspension components may cause loss of vehicle control and result in an accident involving personal property damage, serious injury and/or death.

2. If the bolt holes in the hangers are worn, the hangers should be replaced.

CAUTION

Contact the vehicle manufacturer for specific instructions regarding the removal of old hangers and installation of new hangers. Improper cutting and welding of these components can adversely affect the structural integrity of the vehicle frame.

Spring Eye Bushing Replacement:

1. Remove the old bushings from the spring eyes, driving them out with a suitable drift punch. Make sure the spring eyes are clean and free from excessive wear, burrs and sharp edges before proceeding. Springs that have been damaged in any way must be replaced.
2. Drive the new bronze bushings into the spring eyes. The preferred method is to use a piloted punch that closely fits the inside diameter of the bushing. If a punch is not available, a 9/16" bolt can be substituted. Place the bushing squarely against the spring eye, insert the punch (or bolt) into the bushing and drive it into place by firmly striking the punch (or bolt) with a suitable hammer.

CAUTION

Striking the bronze bushing directly with a hammer may deform the inside diameter and prevent reassembly of the bolts.

REASSEMBLY Tandem Axle Suspension:

Note: Some trailer designs or tire sizes may prevent easy access to the grease fittings when assembled in the suggested fashion. The user may choose to assemble the spring attaching bolts and shackle link assemblies from the opposition direction. This will place the grease fittings on the inboard side of the frame. *OR* The standard 1/4"-28 straight grease fittings can be removed and replaced with an angled fitting. These fittings should be available at most automotive parts store.

1. Slide the front and rear axles into position under the frame hangers. Starting with the front axle, lift the front ends of the springs and position them between the legs of the front hangers with the bolt holes aligned.
2. Insert the lubricated spring eye bolts through the outside leg of the hanger, the spring eye and start it through the inside leg of the hanger.

CAUTION

Note the specific radial orientation of the grease holes in the illustrations. Failure to orient the grease holes as shown may restrict the free flow of lubricant and lead to excessive wear.

3. Read and observe the following cautions before driving the bolts into place.

CAUTION

DO NOT HAMMER directly on the grease fitting. Striking the fitting will cause damage and render it inoperable

CAUTION

Attempts to pull the bolt into place with an impact wrench may strip the threads or cause the bolt to spin and damage the hanger hole and/or bolt spline.

4. Use a suitable hammer to drive the bolt into place. To drive the bolts in, place a small piece of pipe or steel tubing against the head of the bolt. The tube should be approximately 3/8" inside diameter to encircle the grease fitting in the head of the bolt. Strike the end of the tube squarely and firmly. Avoid glancing blows.
5. Continue driving the bolts into the hangers until the bolt heads are seated against the hanger surface. Install the flanged locknut onto the bolt threads with the flanged side of the nut toward the hanger. Tighten the nuts to 30 - 50 ft. lbs. The nut should be seated against the shouldered bolt end.
6. Place the rear ends of the rear axles springs between the legs of the rear hangers. Insert the lubricated spring eye bolts through the outside leg of the hanger, the spring eye and start it through the inside leg of the hanger.

CAUTION

Note the specific radial orientation of the grease holes in the illustrations. Failure to orient the grease holes as shown may restrict the free flow of lubricant and lead to excessive wear.

7. Repeat the steps #4 & 5.
8. Install the new equalizers by placing them inside their center hangers, align the center hole of the equalizer to the holes in the hanger and insert the non-lubricated bolt. Install the flanged locknut onto the bolt threads with the flanged side of the nut toward the hanger. Tighten the nuts to 30 - 50 ft. lbs. The nut should be seated against the shouldered bolt end.
9. Attach the shackle link/bolt assemblies to the equalizers and spring eyes. The axles must be lifted into their normal operating position with the spring eyes above the lower holes in the equalizers. Insert the shackle link/bolt

- subassembly into both the equalizer and spring eye at the same time.
10. Slide the plain shackle links onto the bolt ends that protrude through the springs and equalizers. Install the flanged lock nuts onto the bolts and tighten to 30-50 ft. lbs.
 11. Check the suspension for freedom of movement by lifting either of the axles. When one axle is lifted, the other should move downward and should return to its normal position when the lifting force is released.
 12. Lubricate all the grease fittings using a Lithium complex soap grease, NLGI No. 2 such as Mobile Oil Company Mobilgrease HP or equivalent. Pump the grease in until it begins to show at the ends of the bronze bushings. For best results, the suspension should be lubricated every 3,000 miles.
 13. Reinstall the tire/wheel assemblies, following the instructions provided by the manufacturer.

REASSEMBLY

Triple Axle Suspension:

1. Slide the front, center and rear axles into position under the frame hangers. Starting with the front axle, lift the front ends of the springs until they are positioned between the legs of the front hangers and are aligned to the bolt holes.
2. Insert the lubricated spring eye bolts through the outside leg of the hanger, the spring eye and start it through the inside leg of the hanger.

CAUTION

Note the specific radial orientation of the grease holes in the illustrations. Failure to orient the grease holes as shown may restrict the free flow of lubricant and lead to excessive wear.

3. Read and observe the following cautions before driving the bolts into place.

CAUTION

DO NOT HAMMER directly on the grease fitting. Striking the fitting will cause damage and render it inoperable.

CAUTION

Attempts to pull the bolt into place with an impact wrench may strip the threads or cause the bolt to spin and damage the hanger hole and/or bolt spline.

4. Use a suitable hammer to drive the bolt into place. To drive the bolts in, place a small piece of pipe or steel tubing against the head of the bolt. The tube should be approximately $\frac{3}{8}$ " diameter inside to encircle the grease fitting in the head of the bolt. Strike the end of the tube squarely and firmly. Avoid glancing blows.
5. Continue driving the bolts into the hangers until the bolt heads are seated against the hanger surface. Install the flanged locknut onto the bolt threads with the flanged side of the nut toward the hanger. Tighten the nuts to 30 - 50 ft. lbs. The nut should be seated against the shouldered bolt end.
6. Install the new front equalizer by placing it inside the center hanger, align the center hole of the equalizer to the holes in the hanger and insert the non-lubricated bolt. The yoke end of the equalizer must be toward the rear of the vehicle.
7. Continuing with the center axle, lift the front ends of the springs until they are positioned in the yoke ends of the front equalizers and are aligned to the bolt holes. Insert the lubricated bolts through the holes taking care to orient the grease holes as previously noted. Assemble and tighten the nuts to 30 - 50 ft. lbs. The nuts should be seated against the shouldered bolt ends.
8. Place the rear ends of the rear axles springs between the legs of the rear hangers. Insert the lubricated spring eye bolts through the outside leg of the hanger, the spring eye and start it through the inside leg of the hanger. Make sure the grease holes are oriented as previously noted. Assemble and tighten the nuts to 30 - 50 ft. lbs. The nuts should be seated against the shouldered bolt ends.
9. Attach the shackle link/bolt assemblies to the equalizers and spring eyes. The axles must be lifted into their normal operating position with the spring eyes above the lower holes in the equalizers. Insert the shackle link/bolt subassembly into both the equalizer and spring eye at the same time.
10. Slide the plain shackle links onto the bolt ends that protrude through the springs and equalizers. Install the flanged lock nuts onto the bolts and tighten to 30-50 ft. lbs.
11. Check the suspension for freedom of movement by lifting any one of the axles. When one axle is lifted, the others should move downward and should return to their normal position when the lifting force is released.
12. Lubricate all the grease fittings using a Lithium complex soap grease, NLGI No. 2 such as Mobile Oil Company Mobilgrease HP or equivalent. Pump the grease in until it begins to show at the ends of the bronze bushings. For best results, the suspension should be lubricated every 3,000 miles.
13. Reinstall the tire/wheel assemblies, following the instructions provided by the manufacturer.

Hanger Identification:

If Static Bump Clearance is greater than 2.5", a bump stop should be used to avoid overstressing of leaf springs. Static Bump Clearance of less than 1.5" may limit full suspension movement and result in possible damage to the frame and/or axles when operating on some rough and uneven road surfaces. Tire clearance should always be greater than bump clearance to help prevent tire contact to underbody surfaces in the event of a suspension component failure.

Hanger Identification Chart

Hanger Kit		Hanger Part Numbers and Height Dimensions					
Boxed Part No.	Loose Part No.	Front	Height	Center	Height	Rear	Height
HGR-104-10	HGR-104-00	028-005-00	3¼"	N/A	N/A	030-020-00	29/32"
HGR-248-10	HGR-248-00	028-005-00	3¼"	029-031-00	3 ⁵ / ₈ "	028-005-00	3¼"
HGR-348-10	HGR-348-00	028-005-00	3¼"	029-031-00	3 ⁵ / ₈ "	028-005-00	3¼"

Parts Identification:

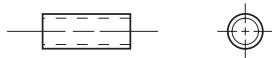

Bronze Bushing

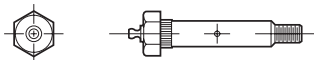

Grease Lubricated Step Bolt

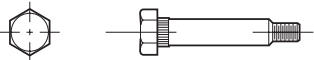

Non-Grease Lubricated Step Bolt

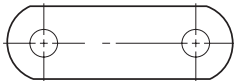

Shackle Link

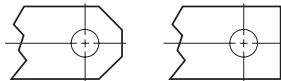

Optional End Designs

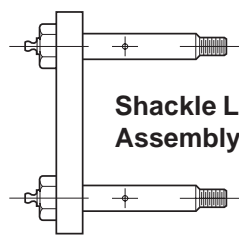
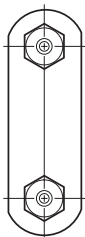

Shackle Link Assembly

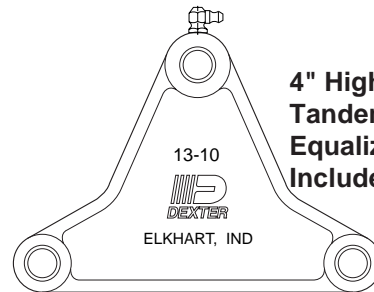

4" High Tandem Axle Equalizer Included in K71-448-00

Tandem Axle Equalizer Included in K71-359-00 and Rear Equalizer for Triple Axle Kit K71-360-00

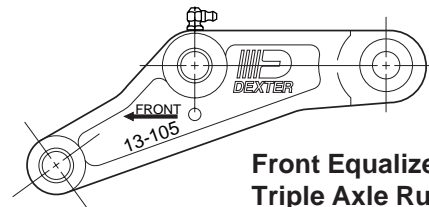
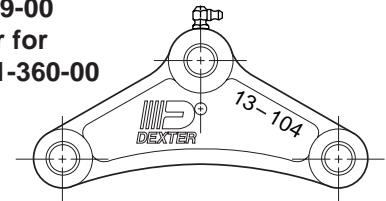

Front Equalizer for Triple Axle Running Gear Included in K71-360-00

Note: Equalizers not shown are 13-122 included in K71-449-00 and K71-453-00, and 13-126 included in K71-453-00.

Single Axle Kit - K71-358-00

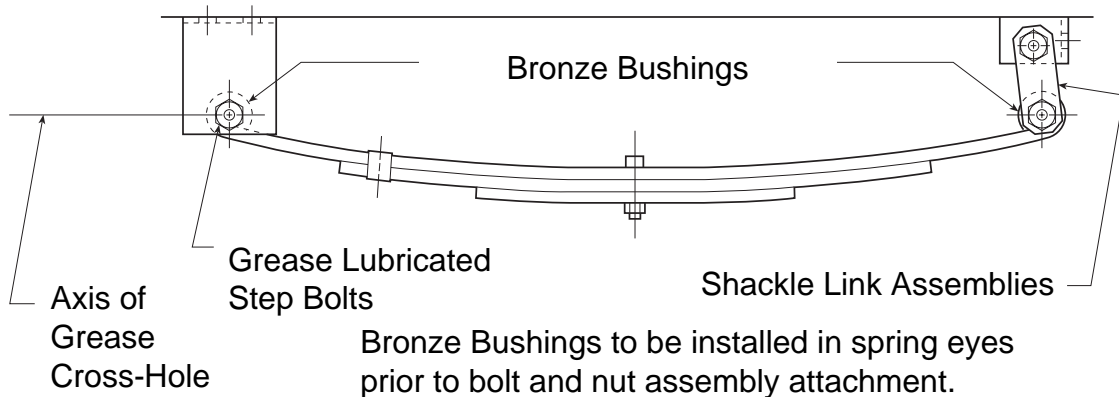

Typical Tandem Axle Installation

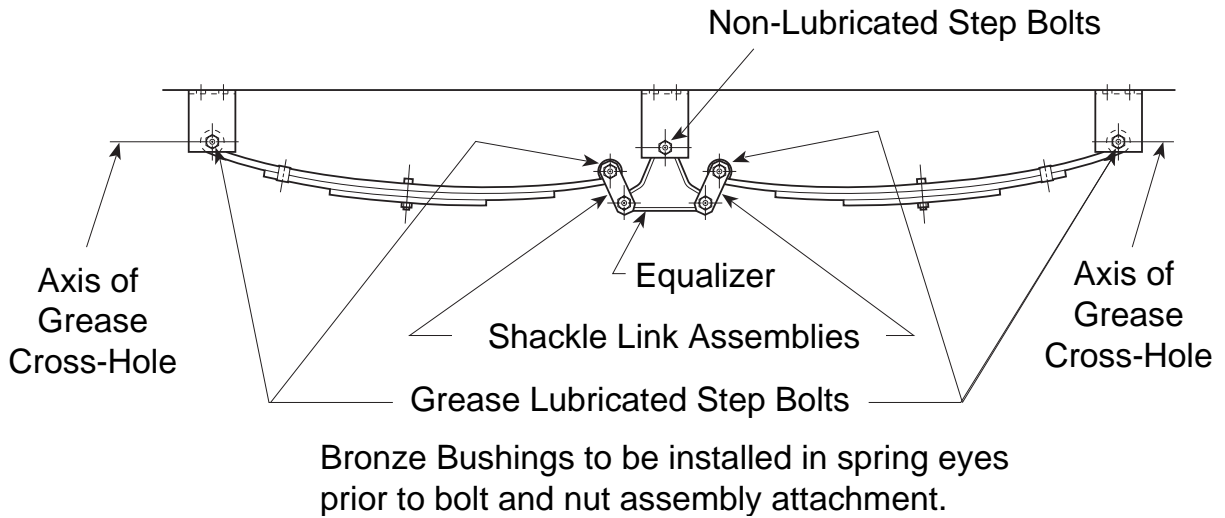

Typical Triple Axle Installation

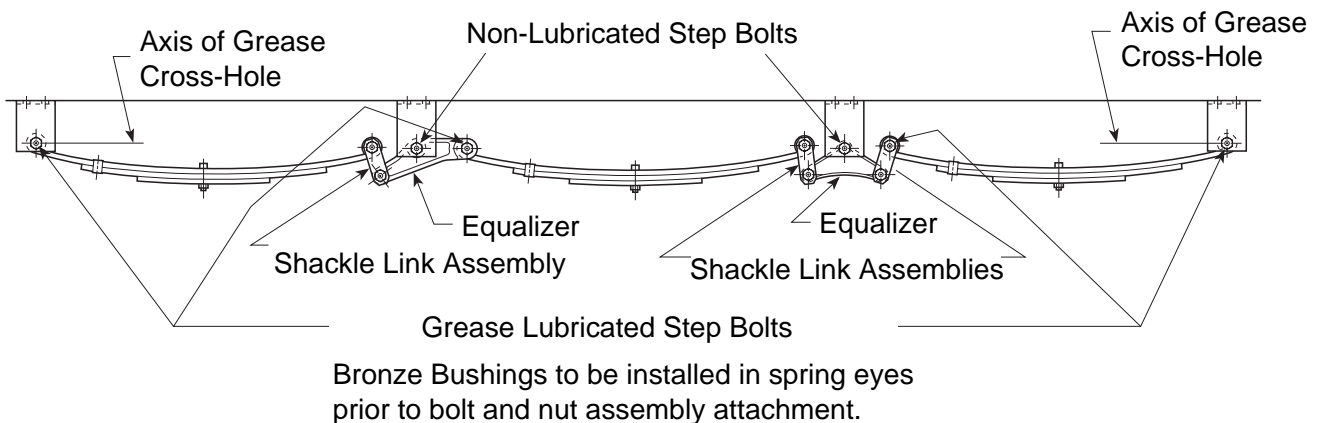

E-Z Flex® Equalizer for Tandem Axles

Using Double Eye Springs for Kits

K71-652-00; K71-653-00; K71-654-00; K71-655-00

Follow safety precautions and trailer raising instructions as outlined on 059-547-00 instruction sheets.

Install new upgrade equalizer into center pivot hanger as stated below in steps #1 through #3

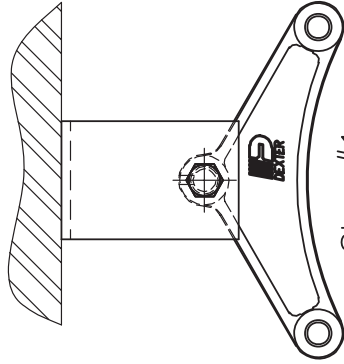

Step #1

Remove existing equalizers from center hangers. Discard center pivot bolt and nut.

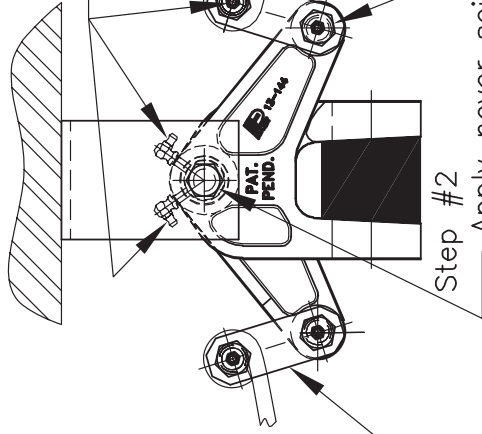

Step #2

Grease Lubricated Step Bolts.

Maintain zerks with grease for better Life results.



Center pivot bolt.
Part No. 007-003-01



Center pivot nut.
Part No. 006-007-01

Step #3

Install the preassembled link and bolt assemblies into the spring eyes and equalizer eyes. Install the loose links onto the bolts. Install the flanged lock nut onto the bolt threads with the flanged side of the nuts toward the links. Tighten the nuts to 30 – 50 ft. lbs. The nut should be seated against the bolt shoulder step. This provides clearance between the parts so that the spring and equalizer eyes are free to rotate.

Apply never seize or equivalent to steel bushing I.D. and Center Bolt O.D. prior to installing the center bolt.

Use a suitable hammer to drive the pivot bolt into place until the bolt head is seated against the hanger surface. Install the lock nut and tighten to 65 – 75 ft. lbs. thereby pinching the protruding steel bushing between the inside hanger side surfaces.

CAUTION

If your center hanger has a welded reinforcement tube, you must check for adequate clearance of the grease zerks.